

# Aviation & Military History

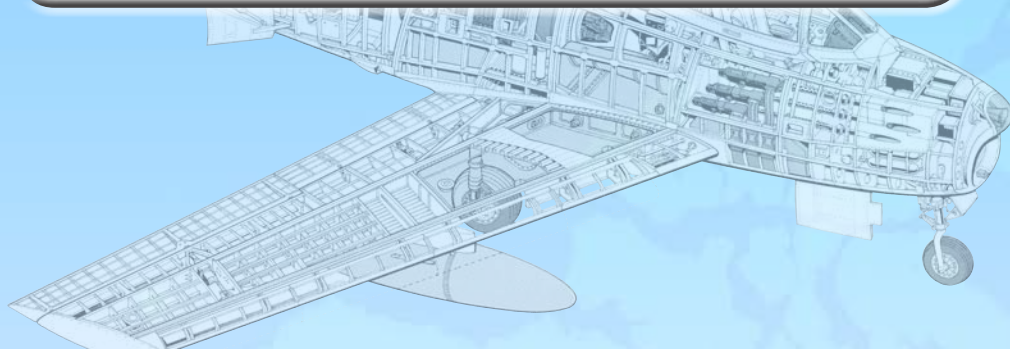

# AVIATION JET AGE



Available December 2012

## B-52 Stratofortress

The Complete History of the World's Longest Serving and Best Known Bomber

Bill Yenne

The B-52's development and five decades of service, from the Cold War and Vietnam to the Gulf Wars and Afghanistan, are featured in this comprehensive and heavily illustrated history.

Paperback • 8.25 x 10.625 in

192 pages • 100 color & 100 b/w photos

194858 AP • 978-0-7603-4302-9

\$35.00 US/\$39.00 CAN/£20.00 UK



## Fly Navy

Celebrating the First Century of Naval Aviation

Erik Hildebrandt

An epic picture book commemorating 100 years of Naval Aviation, *Fly Navy!* Captures the pinnacle achievements that demonstrate how far the Navy has progressed over the last century.

Hardcover • 9 x 12 in

400 pages • 300 color photos

192732 AE • 978-0-96740-408-0

\$65.00 US/\$72.00 CAN



## Flying the SR-71 Blackbird

In the Cockpit on a Secret Operational Mission

Col. Richard H. Graham, USAF (ret.) and Jay K. Miller

A rare cockpit perspective on flying the SR-71, from the foremost expert on piloting the Blackbird.

Hardcover • 6 x 9 in

304 pages • 31 color & 248 b/w photos

144576 AP • 978-0-7603-3239-9

\$28.00 US/\$30.00 CAN/£18.99 UK



## Owners' Workshop Manual Avro Vulcan

1952 Onwards (all marks)

Alfred Price and Tony Blackman

Read about the Vulcan's operational history and take a close-up look at its construction. Discover what it takes to own and fly the mighty V-bomber, and find out how engineers keep it airworthy.

Hardcover • 8.25 x 10.5 in

160 pages • 180 color & 50 b/w photos

192429 AE • 978-1-84425-831-4

\$34.95 US/\$38.99 CAN



## Grumman F-14 Tomcat

Bye-Bye Baby...!: Images & Reminiscences From 35 Years of Active Service

Dave Parsons, George Hall and Bob Lawson

This book is a grand remembrance of this great aircraft by those who flew it, including exceptional color photography of the F-14 on deck, in the air and over the sea.

Paperback • 12 x 9.33 in

200 pages • 257 color photos

149861 AP • 978-0-7603-3981-7

\$29.99 US/\$32.99 CAN/£20.00 UK



## A Hundred Feet Over Hell

Flying With the Men of the 220th Recon Airplane Company Over I Corps and the DMZ, Vietnam 1968-1969

Jim Hooper

*A Hundred Feet Over Hell* is the story of a handful of young pilots taking extraordinary risks to support those on the ground.

Hardcover • 5.5 x 8.5 in

272 pages • 2 maps

147180 AP • 978-0-7603-3633-5

\$25.00 US/\$27.50 CAN/£17.00 UK



## Owners' Workshop Manual McDonnell Douglas

### F-4 Phantom

1958 Onwards (all marks)

Ian Black

The F-4 Phantom remained at the forefront of US air power throughout the 1970s and 1980s. It saw extensive action during the Vietnam War as the principal air superiority fighter for both the US Navy and Air Force, as well as in the ground-attack and reconnaissance roles.

Hardcover • 8.25 x 10.5 in

160 pages • 200 color & 30 b/w photos

200173 AE • 978-1-84425-996-0

\$29.95 US/\$32.99 CAN



## Naked in Da Nang

A Forward Air Controller in Vietnam

Mike Jackson, Tara Dixon-Engel and Frank Borman

FACs (forward air controllers) in Vietnam flew low and slow, searching for signs of an elusive enemy. For friendly units, having a FAC overhead often made the difference between life and death.

Paperback • 6 x 9 in

304 pages • 36 color & 13 b/w photos

149778 AP • 978-0-7603-3916-9

\$17.99 US/\$19.99 CAN/£14.99 UK



## Owners' Workshop Manual North American F-86 Sabre

1947 onwards (all day fighter variants)

Mark Linney

The centerpiece of this Haynes Manual is Golden Apple Operations' F-86A, 48-178, the sole surviving airworthy example of the first production Sabre A model, as well as the world's oldest flying jet-powered aircraft.

Hardcover • 8.53 x 10.88 in

160 pages • 250 color & 50 b/w photos

194818 AP • 978-0-7603-4292-3

\$28.00 US/\$30.00 CAN



NEW

### Stealth Fighter

A Year in the Life of an F-117 Pilot

Lt. Col. William B. O'Connor, USAF (ret.)

The F-117 Stealth Nighthawk was a truly groundbreaking aircraft when introduced in the early 1980s. The strange shape of the jet, all flat panels and angles, rendered the aircraft nearly invisible to radar. Brad O'Connor flew the Nighthawk during the NATO bombing campaign over Kosovo in 1999. His first-person experience puts the reader in the cockpit of this revolutionary combat aircraft. From his F-117 assignment through training, deployment, mission planning, and combat flights, O'Connor relates the day-to-day life of a pilot in the world's first stealth fighter.

Hardcover • 6.25 x 9.25 in

424 pages • 31 color & 12 b/w photos

193495 AP • 978-0-7603-4135-3

\$30.00 US/\$33.00 CAN/£19.99 UK



### TSR2

Britain's Lost Bomber

Damien Burke

This fascinating new book describes in detail the aircraft, its history and the events of its cancellation, and includes many unseen photographs.

Hardcover • 8.6 x 11 in

336 pages • 215 color & 232 b/w photos

193727 AE • 978-1-84797-211-8

\$65.00 US/\$72.00 CAN



Available December 2012

### Unblinking

Inside the Revolution of Unmanned Aircraft

Erik Hildebrandt

A colorful and artistic approach to a somewhat obscure corner of military aviation. Powerful discussions with insiders and policy makers regarding the use and development of near-future systems.

Hardcover • 12 x 9 in

400 pages • 300+ color photos

200807 AE • 978-0-96740-409-7

\$40.00 US/\$44.00 CAN



### Viper Force

56th Fighter Wing--To Fly and Fight the F-16

John M. Dibbs and Lt. Col. Robert "Cricket" Renner, USAF (Ret.)

*Viper Force* tells the story of what it takes to become an F-16 pilot and what it's like to fly and fight the Viper in combat.

Hardcover • 11.125 x 9.5 in

192 pages • 300 color photos

149928 AP • 978-0-7603-4032-5

\$40.00 US/\$44.00 CAN/£30.00 UK



See Page 3



See Above



### B-52 Stratofortress

- The B-52 Stratofortress is the longest serving aircraft in the current U.S. Air Force inventory and is slated to continue service through 2040.
- Covers the development and manufacture of the B-52, in addition to its combat service.
- The author is a well-known military historian and author of several combat aviation books.

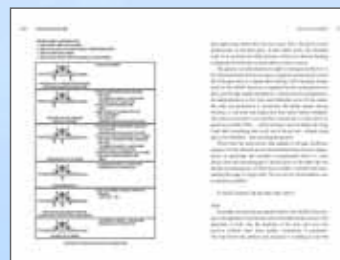

### Stealth Fighter

- The first complete pilot's account of flying stealth sorties in the Kosovo War, including the first and only time an F-117 was shot down by enemy fire.
- The rise of the Predator and other unmanned aerial vehicles brings out the "romance" of the age of piloted fighter planes, with the F-117 being a modern classic.
- Aviation aficionados will enjoy this chance to "fly" the F-117, put into the cockpit with first-person stories.



Available June 2012

**American Missiles**  
The Complete Smithsonian Field Guide  
Brian D. Nicklas  
Hardcover • 6.5 x 9 in  
336 pages • color and b/w photos  
199939 AE • 978-1-84832-517-3  
\$60.00 US/\$65.00 CAN



**American X & Y Planes**  
Volume 1: Experimental Aircraft to 1945  
Kev Darling  
Hardcover • 7.5 x 10 in  
176 pages • 100 b/w photos  
181008 AE • 978-1-84797-141-8  
\$34.95 US/\$43.99 CAN



**American X & Y Planes**  
Volume 2: Experimental Aircraft Since 1945  
Kev Darling  
Hardcover • 7.4 x 9.7 in  
176 pages • 100 color and b/w photos  
181012 AE • 978-1-84797-147-0  
\$34.95 US



**Anytime, Baby!**  
Hail and Farewell to the US Navy F-14 Tomcat  
Erik Hildebrandt, Capt. Dale Snodgrass and Dave Parsons  
Hardcover • 12 x 9.5 in  
180 pages • 200 color photos  
144118 AE • 978-0-96740-405-9  
\$49.95 US/\$55.00 CAN



**Black Tuesday Over Namsi**  
B-29s vs MiGs - the Forgotten Air Battle of the Korean War, 23 October 1951  
Earl McGill, Lt. Col USAF (Ret.)  
Hardcover • 6 x 9 in  
176 pages • 65 b/w photos  
199878 AE • 978-1-90767-721-2  
\$49.95 US/\$55.00 CAN

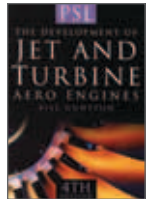

**The Development of Jet and Turbine Aero Engines**  
Bill Gunston  
Paperback • 6.9375 x 9.1825 in  
272 pages • 250 b/w photos  
146271 AE • 978-1-85260-618-3  
\$22.95 US/\$24.95 CAN

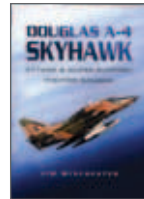

**Douglas A-4 Skyhawk**  
Attack and Close-Support Fighter Bomber  
Jim Winchester  
Hardcover • 7.0 x 10.0 in  
256 pages • 50 color & 80 b/w photos  
146339 AE • 978-1-84415-085-4  
\$50.00 US



**English Electric Lightning**  
Martin W. Bowman  
Paperback • 8.75 x 11 in  
200 pages • 20 color & 170 b/w photos  
140142 AE • 978-1-86126-737-5  
\$29.95 US



**At War**  
**F-100 Super Sabre at War**  
Thomas E. Gardner  
Paperback • 8.25 x 10.625 in  
128 pages • 21 color & 113 b/w photos  
144273 AP • 978-0-7603-2860-6  
\$21.95 US/\$23.95 CAN/£13.99 UK



**F-14 Tomcat**  
Frederic Lert  
Paperback • 8 x 9.5 in  
84 pages • 200 b/w photos  
180979 AE • 978-2-35250-073-5  
\$19.95 US/\$31.99 CAN



**At War**  
**F-15 Eagle at War**  
Tyson V. Ringer  
Paperback • 8.25 x 10.625 in  
160 pages • 126 color & 7 b/w photos  
145650 AP • 978-0-7603-3350-1  
\$24.99 US/\$27.50 CAN/£15.99 UK



**F-16 A and B Versions**  
Volume 1 Fighting Falcon  
Frederic Lert  
Paperback • 7.8 x 9.2 in  
80 pages • 150 b/w photos  
199887 AE • 978-2-35250-129-9  
\$19.95 US/\$21.99 CAN



Available October 2012

**Hawker Siddeley/BAe Harrier**  
1960 Onwards (All Marks)  
Denis Calvert  
Hardcover • 8.27 x 10.64 in  
160 pages • 75 b/w & 225 color illustrations  
200697 AE • 978-0-85733-079-6  
\$35.95 US/\$39.95 CAN



**Loud and Clear**  
The Memoir of an Israeli Fighter Pilot  
Iftach Spector  
Hardcover • 6 x 9 in  
432 pages • 26 b/w photos  
147178 AP • 978-0-7603-3630-4  
\$30.00 US/\$32.95 CAN/£19.00 UK



**McDonnell F-4 Phantom**  
Volume 2: US Air Force and E  
Gerard Paloque  
Paperback • 8 x 9.5 in  
80 pages • color photos  
193797 AE • 978-2-35250-149-7  
\$19.95 US/\$21.99 CAN



**MIG Menace Over Korea**  
Nicolai Sutiagin, Top Ace Soviet of the Korean War  
Yuri Sutiagin  
Hardcover • 6 x 9 in  
256 pages • 40 b/w photos  
199912 AE • 978-1-84884-038-6  
\$40.00 US/\$43.99 CAN



### Mikoyan-Gurevich MIG 21

Fishbed 1955-2010  
Gerard Paloque  
Paperback • 7.8 x 9.3 in  
96 pages • b/w photos  
199913 AE • 978-2-35250-147-3  
\$19.95 US/\$21.99 CAN



### Mirage III-C

From 1955 - 2000  
Dominique Breffort  
Paperback • 8 x 9.5 in  
80 pages • color photos  
180980 AE • 978-2-35250-033-9  
\$19.95 US/\$28.99 CAN



### Post-War US Navy Air Carriers

Martin W. Bowman  
Paperback • 7 x 10 in  
256 pages • 60 color & 200 b/w photos  
199916 AE • 978-1-84868-494-2  
\$29.95 US/\$32.99 CAN



### Profiles of Flight V Bombers

Vulcan, Valiant and Victor  
Dave Windle  
Hardcover • 6.5 x 9.5 in  
80 pages • 30 color & 30 b/w photos  
180959 AE • 978-1-84415-827-0  
\$39.99 US/\$49.99 CAN



### Owners' Workshop Manual RAF Typhoon

1994 onwards (all marks)  
Antony Loveless  
Hardcover • 8.25 x 10.5 in  
160 pages • 200 color photos  
196365 AE • 978-0-85733-075-8  
\$29.95 US/\$32.99 CAN



Available July 2012

### Owners' Workshop Manual Red Arrows

1965 Onwards (all marks)  
Antony Loveless  
Hardcover • 8.25 x 10.6 in  
160 pages • 250 color photos  
200179 AE • 978-0-85733-104-5  
\$29.95 US/\$32.99 CAN



### Red Arrows in Camera

Keith Wilson  
Hardcover • 9.85 x 9.85 in  
192 pages • 25 b/w & 250 color illustrations  
200691 AE • 978-0-85733-154-0  
\$40.00 US/\$44.00 CAN



### Rupert Red Two

A Fighter Pilot's Life From Thunderbolts to Thunderchiefs  
Jack Broughton and Dr. Richard P. Hallion  
Hardcover • 6 x 9 in  
352 pages • 33 b/w photos  
145506 AP • 978-0-7603-3217-7  
\$26.95 US/\$29.95 CAN/£16.99 UK



### SR-71 Blackbird

Stories, Tales, and Legends  
Rich Graham  
Hardcover • 6 x 9 in  
256 pages • 50 b/w photos  
135112 AP • 978-0-7603-1142-4  
\$28.00 US/\$34.99 CAN/£16.99 UK



### SR-71 Revealed

The Inside Story  
Col. Richard H. Graham, USAF (ret.)  
Paperback • 6 x 9 in  
224 pages • 75 b/w photos  
122803 AP • 978-0-7603-0122-7  
\$17.99 US/\$19.95 CAN/£10.99 UK



### Stratofortress

The Story of the B-52  
Martin W. Bowman  
Hardcover • 6.75 x 9.5 in  
320 pages • 200 color photos  
144974 AE • 978-1-84415-234-6  
\$50.00 US

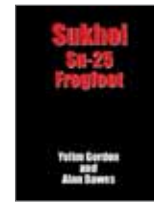

### Sukhoi Su-25 Frogfoot

Close Air Support Aircraft  
Yefim Gordon  
Hardcover • 7.75 x 10.125 in  
192 pages • 30 color & 180 b/w photos  
136200 AE • 978-1-84037-353-0  
\$49.95 US



### Turbojet

History and Development 1930-1960  
Volume 1 - Great Britain and Germany  
Antony L. Kay  
Hardcover • 11 x 11 in  
240 pages • 600 b/w photos  
145926 AE • 978-1-86126-912-6  
\$69.95 US



### Turbojet

History And Development 1930-1960  
Volume 2: USSR, USA, Japan, France, Canada, Sweden, Switzerland, Italy and Hungary  
Anthony L. Kay  
Hardcover • 8.5 x 11 in  
240 pages • 300 b/w photos  
146129 AE • 978-1-86126-939-3  
\$69.95 US

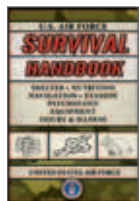

### U.S. Air Force Survival Handbook

U.S. Air Force  
Paperback • 8.5 x 11 in  
592 pages • 1000 b/w photos  
192787 AE • 978-1-60239-245-8  
\$17.95 US/\$22.50 CAN



### U.S.A.F. Tactical Reconnaissance in the Cold War

1945 to Korea, Cuba, Vietnam and The Iron Curtain  
Paperback • 7 x 10 in  
256 pages • 350 color photos  
144920 AE • 978-1-84415-332-9  
\$50.00 US

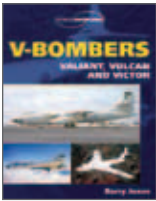

### V-Bombers

Valiant, Vulcan and Victor  
Barry Jones

Paperback • 8.75 x 11 in  
200 pages • 20 color & 200 b/w photos  
146380 AE • 978-1-86126-945-4  
\$34.95 US/\$38.95 CAN



### Voodoo Warriors

The Story of the McDonnell Voodoo Fast-jets  
Nigek Walpole

Hardcover • 7.25 x 100 in  
320 pages • 300 color photos  
146175 AE • 978-1-84415-414-2  
\$50.00 US



### The World Air Power Guide

David Wragg  
Hardcover • 6 x 9 in  
240 pages • 100+ b/w photos  
199932 AE • 978-1-84884-282-3  
\$50.00 US/\$55.00 CAN



### Yakovlev YAK-23

The First Yakovlev Jet Fighters  
Marian Micolajczuk  
Paperback • 7 x 10 in  
152 pages • 135 color & 100 b/w photos  
193822 AE • 978-8-38945-054-8  
\$27.00 US/\$29.99 CAN

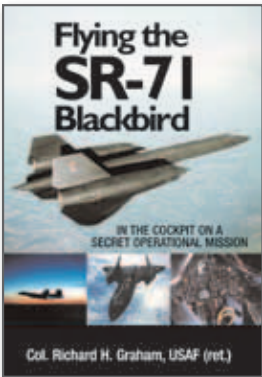

"For anyone who has ever wondered what it's like to fly the SR-71 on a secret Mach 3 reconnaissance mission, *Flying the SR-71 Blackbird* has the answer."

— Pacific Flyer



See Page 2

### Flying the SR-71 Blackbird

- The larger airshows like Oshkosh attract attendance of more than 700,000 each year.
- The first book to take readers step-by-step through a typical classified SR-71 mission.
- Written by possibly the world's foremost expert on piloting the Blackbird.



See Page 3

### Unblinking

- Unprecedented access provides rarely seen units deployed overseas and here in the US.
- Stunning aerial images and insightful writings by front line operators and policy chiefs.
- In depth discussion of pros and cons of the use of unmanned aircraft both for reconnaissance and for tactical offensive attacks.

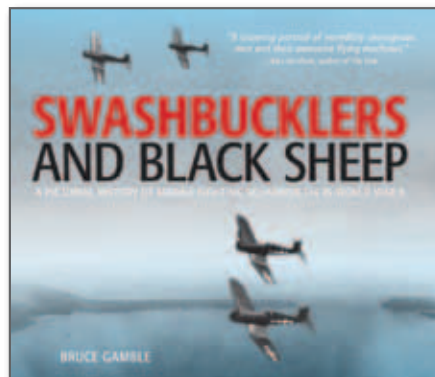

"When we're still learning things about the Civil War 150 years later, it should be little surprise to find new material from World War II. But Bruce Gamble's fabulous treatment of the Black Sheep sets a new standard for 'above and beyond' his previous definitive treatments of VMF-214. Combining insightful text with a fabulous collection of photos and high quality art, this book raises the bar in a field that routinely sees new material and fresh interpretations. An absolute treasure."

— Barrett Tillman, author of *Enterprise: America's Fightingest Ship and the Men Who Helped Win World War*



See Page 8

### Swashbucklers and Black Sheep

- The Black Sheep are World War II's most famous combat aviation squadron.
- This is the first illustrated history of the Black Sheep.
- Author Bruce Gamble is a recognized authority on the Black Sheep and their charismatic World War II commander Greg "Pappy" Boyington.

# AVIATION WW2



## Corsair 1940-1970

Bruno Pautigny

The Vought F4U-Corsair, a real monster of a plane, was used throughout World War II and was still in service at the time of the Korean War. This complete illustrated history of one of the most successful aircraft types to emerge from the war will be a dream book for anyone with an interest in this aircraft.

Hardcover • 9.25 x 12.5 in  
144 pages • color photos  
140377 AE • 978-2-91390-328-9  
\$34.95 US/\$38.99 CAN



## Hell Hawks!

The Untold Story of the American Fliers Who Savaged Hitler's Wehrmacht

Robert F. Dorr and Thomas D. Jones

This is the story of the daring P-47 fighter-bomber pilots of the famed 365th Fighter Group—the "Hell Hawks"—as they engaged Hitler's vaunted military machine across Europe during World War II.

Hardcover • 6.50 x 9.25 in  
336 pages • 55 b/w photos  
139414 AP • 978-0-7603-2918-4  
\$24.95 US/\$27.95 CAN/£16.99 UK  
Paperback  
149651 AP • 978-0-7603-3825-4  
\$17.99 US/\$19.99 CAN/£14.99 UK



## Owners' Workshop Manual Boeing B-17 Flying Fortress

1935 Onwards (all marks)

Graeme Douglas

This is a unique guide for anyone wishing to own and operate a Boeing B-27 Flying Fortress as well as an insight into the engineering and contribution of this remarkable airplane; includes a developmental history of the aircraft, cutaway drawings, and the restoration and repair process.

Hardcover • 8.5 x 10.875 in  
160 pages • 200 color & 50 b/w photos  
193314 AP • 978-0-7603-4077-6  
\$28.00 US/\$30.00 CAN



## Owners' Workshop Manual Douglas DC-3 Dakota

1935 onwards (all marks)

Paul Blackah

Because of its lasting impact on the airline industry and the part it played in World War II, the Dakota is widely regarded as one of the most significant transport aircraft ever built. This Haynes Manual describes the Dakota's rugged anatomy and examines its operation from the viewpoints of its owners, aircrew, and engineers.

Hardcover • 8.528 x 10.879 in  
160 pages • 250 color & 50 b/w photos  
194817 AP • 978-0-7603-4291-6  
\$28.00 US/\$30.00 CAN

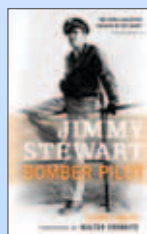

## Jimmy Stewart

Bomber Pilot

Starr Smith and Walter Cronkite

On December 7th, when the attack on Pearl Harbor woke so many to the reality of war, Jimmy Stewart was already in uniform. Seeing war on the horizon, Stewart, at the height of his fame, had enlisted several months earlier. This book chronicles his long journey to become a bomber pilot in combat.

Hardcover • 5.875 x 8.75 in  
288 pages • color photos  
139613 AP • 978-0-7603-2199-7  
\$28.00 US/\$34.99 CAN/£17.99 UK  
Paperback  
144237 AP • 978-0-7603-2824-8  
\$14.95 US/\$17.95 CAN/£8.99 UK



## Bombs Away!

The World War II Bombing Campaigns over Europe

John R. Bruning

*Bombs Away!* covers strategic bombing in Europe during World War II, that is, all aerial bombardment of a strategic nature which took place between 1939 and 1945. All of this is covered in detail with authoritative text and hundreds of archival photographs, many rare or never before published.

Hardcover • 10.75 x 12.25 in  
300 pages • 50 color & 400 b/w photos  
149870 AP • 978-0-7603-3990-9  
\$50.00 US/\$55.00 CAN/£35.00 UK



## The German Aces Speak

World War II Through the Eyes of Four of the Luftwaffe's Most Important Commanders

Colin D. Heaton and Anne-Marie Lewis

For the first time in any book, four prominent German fighter pilots reminisce candidly about their service in World War II. Although all were decorated by the Third Reich, they did not follow the Nazi Party without question, and elected to follow their own code of honor in combat. In the end, they felt that they and their countrymen had been betrayed by Hitler and the Nazis.

Hardcover • 5.75 x 8.75 in  
368 pages • 20 b/w photos  
193427 AP • 978-0-7603-4115-5  
\$29.00 US/\$32.00 CAN/£20.00 UK



## The Me 262 Stormbird

From the Pilots Who Flew, Fought, and Survived It

Colin D. Heaton, Jorg Czipionka and Barrett Tillman

The Me 262 was the first of its kind, the first jet-powered aircraft. Told largely in the words of the German aces who flew it, *The Me 262 Stormbird* provides the complete history of this remarkable airplane from the drawing boards to combat in the skies over the Third Reich. Features two forewords, one by Jorg Czipionka, Me 262 night fighter pilot, and another by historian and author Barrett Tillman.

Hardcover • 5.75 x 8.75 in  
336 pages • 48 b/w photos  
194769 AP • 978-0-7603-4263-3  
\$30.00 US/\$33.00 CAN/£20.00 UK



NEW

### Mission to Berlin

The American Airmen Who Struck the Heart of Hitler's Reich

Robert F. Dorr

Told largely in the veterans' own words, *Mission to Berlin* covers all aspects of a long-range bombing mission including pilots and other aircrew, ground crew, and escort fighters that accompanied the heavy bombers on their perilous mission.

Hardcover • 6.25 x 9.25 in

336 pages • 16 b/w photos

149766 AP • 978-0-7603-3898-8

\$28.00 US/\$30.00 CAN/£20.00 UK



Available September 2012

### Mission to Tokyo

The American Airmen Who Took the War to the Heart of Japan

Robert F. Dorr

*Mission to Tokyo* covers a World War II bombing mission from an airfield on the island of Tinian to Tokyo and back, in the words of pilots and other aircrew.

Hardcover • 6.25 x 9.25 in

336 pages • 17 b/w photos

193454 AP • 978-0-7603-4122-3

\$30.00 US/\$33.00 CAN/£20.00 UK



### Owners' Workshop Manual

#### North American P-51 Mustang

1940 Onwards (all marks)

Jarrod Cotter

The North American P-51 Mustang holds an important place in US aviation history as its finest fighter aircraft of all time. Read about the Mustang's illustrious combat history and take a close-up look at how it is constructed. Discover what it takes to own and fly this classic fighter, and find out how engineers keep it airworthy.

Hardcover • 8.25 x 10.5 in

160 pages • 170 color & 60 b/w photos

192428 AE • 978-1-84425-870-3

\$34.95 US/\$38.99 CAN



### Sharks of the Air

Willy Messerschmitt and How He Built the World's First Operational Jet Fighter

James Neal Harvey

*Sharks of the Air* tells the story of Willy Messerschmitt's life, and shows how this aeronautical genius built many revolutionary airplanes. It describes how his various warplanes fought in Spain, Poland, France, Britain, the U.S.S.R., and over Germany, and it provides thrilling accounts of air battles drawn from combat reports and interviews with veterans.

Hardcover • 6 x 9 in

352 pages • b/w photos

199922 AE • 978-1-93514-946-0

\$32.95 US/\$35.99 CAN



Available October 2012

### The Star of Africa

The Story of Hans Marseille, the Rogue Luftwaffe Ace who Dominated the WWII Skies

Colin D. Heaton and Anne-Marie Lewis

A biography of Hans Marseille, one of the Luftwaffe's most daring and famous pilots during World War II. This book traces his all-too-brief career, as well as his rebellious nature, iconoclastic behavior, and reputation born from his exceptional skill and chivalrous conduct as a pilot.

Hardcover • 5.75 x 8.75 in

240 pages • 25 b/w photos

200332 AP • 978-0-7603-4393-7

\$30.00 US/\$33.00 CAN

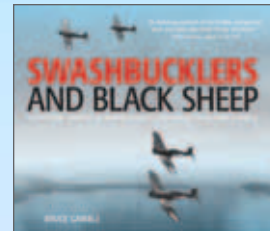

Available September 2012

### Swashbucklers and Black Sheep

A Pictorial History of Marine Fighting Squadron 214 in World War II

Bruce Gamble

*Swashbucklers and Black Sheep* is a comprehensive illustrated history of Marine Fighting Squadron 214 from its formation to their second commander, Greg "Pappy" Boyington, and service beyond World War II.

Hardcover • 11.25 x 9.875 in

216 pages • 24 color & 150 b/w photos

194752 AP • 978-0-7603-4250-3

\$40.00 US/\$44.00 CAN/£25.00 UK



### Vintage Aircraft Nose Art

Gary Valant

Applied by amateurs or professional artists like Vargas, the unique art that graced military aircraft in World War II and the Korean War typically featured alluring women whose charms belied the deadly cargo the crew hoped to deliver to its targets. Hundreds of examples are shown in a combination of archival photos from the wars and current photos of artwork in museum collections.

Paperback • 10.25 x 11.75 in

208 pages • 120 color & 760 b/w photos

133818 AP • 978-0-7603-1208-7

\$29.99 US/\$32.50 CAN/£16.99 UK



### War in Pacific Skies

Charlie Cooper, Ann Cooper, Jack Fellows and Walter J. Boyne

This book covers the most famous air engagements in WWII's Pacific Theater of Operation in an exquisite and beautiful fusion of art and history. Climb into the cockpit of some of America's most heralded war birds: the P-38 that carried Richard Bong to his 40 kills and fly along with Paul Tibbitts in the "Enola Gay" as it makes its final approach on Hiroshima.

Paperback • 11 x 9.625 in

192 pages • 122 color & 100 b/w photos

149780 AP • 978-0-7603-3932-9

\$27.99 US/\$29.99 CAN/£20.00 UK



### Warbird Legends

John Dibbs

Represented in this reference are images of World War II's 20 greatest aircraft—the last of the gladiatorial steeds, from the legendary Mustang, Spitfire, Flying Fortress, and Mitsubishi Zero, to lesser-known but equally awe-inspiring warbirds such as the Mosquito, Blenheim, and Kingcobra.

Paperback • 13.5 x 9.5 in

244 pages • 182 color & 85 b/w photos

130741 AP • 978-0-7603-0967-4

\$27.99 US/\$34.99 CAN/£17.99 UK



**3rd Air Division 8th Air Force  
USAAF 1942-45**  
Flying Fortress and Liberator Squadrons in  
Norfolk and Suffolk  
Martin W. Bowman  
Paperback • 5.5 x 8.5 in  
192 pages • 80 b/w photos  
**180955 AE • 978-1-84415-828-7**  
**\$25.99 US/\$32.50 CAN**



**The 5th Air Force**  
Gerard Paloque  
Paperback • 8 x 10 in  
112 pages • 340 color photos  
**193762 AE • 978-2-35250-137-4**  
**\$29.95 US/\$32.99 CAN**



**8th Air Force**  
American Heavy Bomber Groups in England  
1942-1945  
Gregory Pons  
Hardcover • 9 x 12 in  
192 pages • color photos  
**146337 AE • 978-2-91523-982-9**  
**\$49.95 US**



**9th Air Force**  
American Tactical Aviation in the ETO, 1943-45  
Gregory Pons  
Hardcover • 9.5 x 12.5 in  
196 pages • color photos  
**180950 AE • 978-2-35250-077-3**  
**\$49.95 US/\$75.00 CAN**

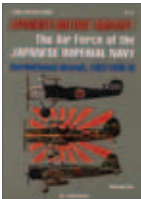

**Japanese Military Aircraft  
The Air Force of the Japanese  
Imperial Navy**  
Carrier-based aircraft, 1922-1945 (I)  
Cea Eduardo  
Paperback • 8.5 x 11.5 in  
120 pages • color photos  
**149071 AE • 978-8-49693-504-4**  
**\$24.95 US**



**Japanese Military Aircraft  
The Air Force of the Imperial  
Japanese Navy, Volume 2**  
Carrier-based aircraft, 1922-1945  
Cea Eduardo  
Paperback • 8.5 x 11.5 in  
120 pages • color photos  
**149072 AE • 978-8-49693-505-1**  
**\$24.95 US**

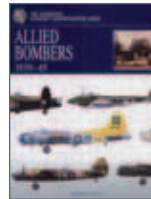

**The Essential Aircraft  
Identification Guide  
Allied Bombers 1939-45**  
Chris Chant  
Paperback • 7.5 x 9.5 in  
192 pages • 410 b/w photos  
**145738 AP • 978-0-7603-3450-8**  
**\$19.95 US/\$21.95 CAN**



**Allied Rotocraft of the  
WW2 Period**  
Ryszard Witkowski  
Paperback • 7 x 10 in  
120 pages • 135 color photos  
**193771 AE • 978-8-38945-097-5**  
**\$25.00 US/\$27.99 CAN**



**The American Aircraft  
Factory in World War II**  
Bill Yenne  
Paperback • 11 x 9.625 in  
192 pages • 64 color & 121 b/w photos  
**149774 AP • 978-0-7603-3913-8**  
**\$24.99 US/\$27.99 CAN/£17.99 UK**

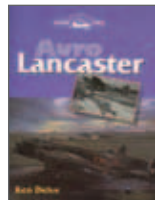

**Avro Lancaster**  
Ken Delve  
Hardcover • 8.5 x 11 in  
192 pages • 190 b/w photos  
**129778 AE • 978-1-86126-222-6**  
**\$44.95 US**



**Owner's Workshop Manual  
Avro Lancaster**  
1941 onwards All marks  
Jarrod Cotter and Paul Blackah  
Hardcover • 8.25 x 10.50 in  
160 pages • 180 color & b/w photos  
**146542 AE • 978-1-84425-463-7**  
**\$34.95 US/\$38.95 CAN**



Available August 2012

**Battle of Britain Pilot**  
Self-Portrait of an RAF Fighter Pilot and Escaper  
George Barclay  
Hardcover • 8.27 x 10.64 in  
256 pages • 125 b/w photos  
**200693 AE • 978-0-85733-239-4**  
**\$40.00 US/\$44.00 CAN**



**Bell P-39 Airacobra**  
Robert Peczkowski  
Paperback • 7 x 10 in  
128 pages • 80 color & 40 b/w photos  
**199875 AE • 978-8-36142-128-3**  
**\$27.00 US/\$29.99 CAN**



**Bf 109 Late Versions**  
Camouflage & Markings  
Krzysztof Wolowski  
Paperback • 8 x 12 in  
96 pages • 50 color & b/w photos  
**199876 AE • 978-8-36142-113-9**  
**\$37.00 US/\$40.99 CAN**



**A Brooklands Aircraft Portfolio  
Boeing B-17 and B-29 Fortress  
and Superfortress Portfolio**  
R.M. Clarke  
Paperback • 8 x 10.75 in  
70 pages • color photos  
**110942 AE • 978-0-94820-790-7**  
**\$19.95 US/\$21.95 CAN**



**Japanese Military Aircraft  
Bombers of the Imperial  
Japanese Army**  
1939-1945  
Cea Eduardo  
Paperback • 8 x 11.6 in  
152 pages • 244 color photos  
**199881 AE • 978-8-49693-523-5**  
**\$42.95 US/\$45.99 CAN**



### Bristol Beaufighter

Jerry Scutts  
Hardcover • 8.5 x 11 in  
192 pages • color photos  
138993 AE • 978-1-86126-666-8  
\$44.95 US



### Curtis Hawk H-75

In French Service  
Lionel Persyn  
Paperback • 6.4 x 8.8 in  
160 pages • 32 color & 200 b/w photos  
199883 AE • 978-8-36142-107-8  
\$25.00 US/\$27.99 CAN



### Owners' Workshop Manual Dam Busters

1943 onwards (all marks and models)  
Iain Murray  
Hardcover • 8.25 x 10.5 in  
160 pages • 50 color & 150 b/w photos  
196358 AE • 978-0-85733-015-4  
\$29.95 US/\$32.99 CAN



### The Dam Busters

Breaking the Great Dams of Western Germany,  
16-17 May 1943  
Jonathan Falconer  
Paperback • 8.25 x 10.5 in  
256 pages • 60 color & 140 b/w photos  
192438 AE • 978-1-84425-867-3  
\$24.95 US/\$27.99 CAN



### De Havilland Moths In Detail

DH60, DH80, DH82, DH83, DH85, DH87, DH94  
Stuart McKay  
Hardcover • 7.5 x 10.25 in  
288 pages • 270 color photos  
149504 AE • 978-1-90613-311-5  
\$79.95 US/\$100.00 CAN



### Owners' Workshop Manual De Havilland Tiger Moth

1931 – 1945 (all marks)  
Stephen Slater and Stuart McKay  
Paperback • 8.5 x 11 in  
160 pages • 150 color & 75 b/w photos  
150047 AE • 978-1-84425-586-3  
\$32.95 US/\$41.50 CAN



### Eighth Air Force Bomber Stories

Eye witness accounts from American Airmen and  
British Civilians in the Second World War  
Ian McLachlan and Russell J. Zorn  
Hardcover • 6.66 x 9.18 in  
224 pages • 190 b/w photos  
200681 AE • 978-0-85733-228-8  
\$31.95 US/\$34.95 CAN



### At War F6F Hellcat at War

Cory Graff  
Paperback • 8.25 x 10.625 in  
160 pages • 58 color & 130 b/w photos  
145461 AP • 978-0-7603-3306-8  
\$24.99 US/\$27.50 CAN/£15.99 UK

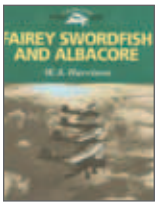

### Fairey Swordfish and Albacore

W.A. Harrison  
Hardcover • 8.5 x 11 in  
192 pages • color photos  
135566 AE • 978-1-86126-512-8  
\$44.95 US



### Flying Guns WWII

Development of Aircraft Guns, Ammunition and  
Installations 1933-45  
Anthony G. Williams  
Hardcover • 7.5 x 9.5 in  
336 pages • color photos  
135879 AE • 978-1-84037-227-4  
\$59.95 US



### Images of War Flying Legends of World War II

Archive and Colour Photos of Famous  
Allied Aircraft  
Philip Handleman  
Paperback • 7.5 x 9.75 in  
112 pages • 120 color & b/w photos  
199889 AE • 978-1-84884-308-0  
\$24.95 US/\$27.99 CAN



### Focke Wulf FW 190

From 1940-1945  
Dominique Breffort  
Paperback • 9.3 x 7.8 in  
80 pages • color photos  
146340 AE • 978-2-91523-925-6  
\$19.95 US/\$21.99 CAN



### The Focke-Wulf Fw 190 Dora

Volume Two  
Jerry Crandall and Doug Champlin  
Hardcover • 9 x 12 in  
400 pages • color photos  
191793 AE • 978-0-97940-351-4  
\$95.00 US/\$120.00 CAN/£120.00 UK



### Fortress Ploesti

The Campaign to Destroy Hitler's Oil Supply  
Jay Stout  
Paperback • 6 x 9 in  
320 pages • b/w photos  
199890 AE • 978-1-93514-939-2  
\$18.95 US/\$20.99 CAN



### German Air Projects

1935-1945 Volume 3  
Marek Rys  
Paperback • 7 x 10 in  
96 pages • 150 color photos  
193782 AE • 978-8-38945-030-2  
\$24.00 US/\$27.99 CAN



### The Hardest Day

The Battle of Britain: 18 August 1940  
Alfred Price  
Hardcover • 6 x 9 in  
256 pages • 70 b/w photos  
192432 AE • 978-1-84425-820-8  
\$34.95 US/\$38.99 CAN



**Owners' Workshop Manual  
Hawker Hurricane**  
1935 onwards (all marks)  
Paul Blackah  
Hardcover • 8.25 x 10.5 in  
160 pages • 175 color & 50 b/w photos  
192446 AE • 978-1-84425-955-7  
\$34.95 US/\$38.99 CAN



**Hawker Hurricane**  
From 1937 to 1950  
Dominique Breffort  
Paperback • 8 x 10 in  
84 pages • 200 color photos  
199897 AE • 978-2-91523-987-4  
\$19.95 US/\$21.99 CAN



**Hawker Hurricane**  
Inside and Out  
Melvyn Hiscock  
Paperback • 7.5 x 10.25 in  
96 pages • color photos  
136586 AE • 978-1-86126-630-9  
\$21.95 US



**Heinkel HE 162 "Volksjäger"**  
Last-Ditch Effort by the Luftwaffe  
Peter Muller  
Hardcover • 8 x 11 in  
430 pages • 220 color photos  
193785 AE • 978-3-95229-681-3  
\$89.00 US/\$100.00 CAN



**Henschel Hs 126**  
Robert Peczkowski  
Paperback • 7 x 11 in  
208 pages • 106 color & 316 b/w photos  
193786 AE • 978-8-38945-040-1  
\$40.00 US/\$43.99 CAN



**Henschel Hs 129**  
Krzysztof Wolowski  
Paperback • 7 x 10 in  
148 pages • 200+ color & b/w photos  
193787 AE • 978-8-38945-046-3  
\$39.00 US/\$43.99 CAN



**Japanese Army Air Force  
Fighter Units and Their Aces**  
1931-1945  
Ikuhiko Hata, Yasuho Izawa and  
Christopher Shores  
Hardcover • 6.25 x 9.5 in  
340 pages • 200+ color photos  
146776 AE • 978-1-90230-489-2  
\$59.95 US



**Japanese Military Aircraft  
Aircraft of the Imperial  
Japanese Navy**  
Land-Based Aviation, 1929-1945 (I) N°4  
Cea Eduardo  
Paperback • 8.25 x 11.5 in  
104 pages • 172 color photos  
180935 AE • 978-8-49693-510-5  
\$29.00 US/\$37.50 CAN



**Japanese Naval Air Force  
Fighter Units And Their Aces,  
1932-1945**  
Ikuhiko Hata  
Hardcover • 6 x 9.25 in  
416 pages • b/w photos  
199898 AE • 978-1-90650-284-3  
\$59.95 US/\$65.00 CAN



**Japanese Special Attack  
Aircraft & Flying Bombs**  
Ryusuke Ishiguro  
Paperback • 8.25 x 11.75 in  
264 pages • 194 b/w photos  
193791 AE • 978-8-38945-012-8  
\$59.00 US/\$65.00 CAN

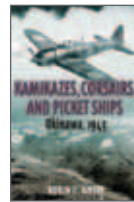

**Kamikazes, Corsairs,  
and Picket Ships**  
Okinawa, 1945  
Robin L. Rielly  
Paperback • 6 x 9 in  
448 pages • b/w photos  
199903 AE • 978-1-93514-941-5  
\$19.95 US/\$21.99 CAN



**Koga's Zero**  
The Fighter That Changed World War II  
J. Rearden  
Paperback • 7 x 9.875 in  
114 pages • 64 b/w photos  
122411 AE • 978-0-92952-156-5  
\$12.95 US



**Kugisho E14Y Glen**  
America Attacker  
Ryusuke Ishiguro  
Hardcover • 8.25 x 11.75 in  
160 pages • 60 color & 200 b/w photos  
199904 AE • 978-8-38945-061-6  
\$59.95 US/\$65.00 CAN



**Last Days of the Luftwaffe**  
German Luftwaffe Combat Units 1944-1945  
Manfred Griebel  
Hardcover • 7.5 x 9.5 in  
320 pages • 180 b/w photos  
180940 AE • 978-1-84832-511-1  
\$50.00 US/\$62.50 CAN



**Images of War  
Liberators in England in  
World War II**  
Peter Bodle  
Paperback • 7.5 x 9.5 in  
144 pages • 120 b/w photos  
193794 AE • 978-1-84415-821-8  
\$25.99 US/\$28.99 CAN



**Messerschmitt Me  
163B Komet**  
Bartłomiej Belcarz  
Paperback • 6.5 x 8.9 in  
148 pages • color photos  
199911 AE • 978-8-38945-051-7  
\$39.00 US/\$43.99 CAN



**Owners' Workshop Manual  
Messerschmitt BF109**  
1935 Onwards (all marks)  
Paul Blackah and Malcolm Lowe  
Hardcover • 8.5 x 11 in  
160 pages • 150 color photos  
150046 AE • 978-1-84425-642-6  
\$32.95 US/\$41.50 CAN



**Messerschmitt Me 110**  
**From 1939 to 1945**  
The Twin Prop Fighting Messerschmitt's Bf 110,  
Me 210 & 410  
Dominique Brefort  
Paperback • 8 x 8.5 in  
84 pages • color photos  
193798 AE • 978-2-35250-144-2  
\$19.95 US/\$24.99 CAN

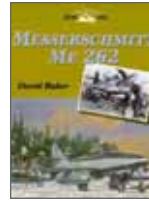

**Messerschmitt Me 262**  
David Baker  
Hardcover • 8.25 x 11 in  
192 pages • 180 b/w photos  
125211 AE • 978-1-86126-078-9  
\$44.95 US

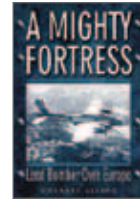

**A Mighty Fortress**  
Lead Bomber Over Europe  
Chuck Alling  
Paperback • 6 x 9 in  
256 pages • b/w photos  
180969 AE • 978-1-93203-359-5  
\$19.95 US/\$24.99 CAN



**The Most Dangerous Enemy**  
An Illustrated History of the Battle of Britain  
Stephen Bungay  
Hardcover • 9.7 x 11.55 in  
272 pages • 25 color & 100 b/w photos  
149785 AP • 978-0-7603-3936-7  
\$40.00 US/\$44.00 CAN



**No Need to Die**  
American Flyers in RAF Bomber Command  
Gordon Thorburn  
Paperback • 6 x 9 in  
262 pages • 16 color & 246 b/w photos  
200121 AE • 978-0-85733-135-9  
\$14.95 US/\$16.99 CAN



**North American  
P-51 Mustang**  
Malcolm Lowe  
Hardcover • 9 x 11 in  
280 pages • 20 color & 280 b/w photos  
181007 AE • 978-1-86126-830-3  
\$49.95 US/\$62.50 CAN



**North American  
P-51D Mustang**  
Robert Peczkowski  
Paperback • 7 x 10 in  
152 pages • 177 color & 85 b/w photos  
193799 AE • 978-8-38945-060-9  
\$27.00 US/\$29.99 CAN



**Petlyakov Pe-2 'Peshka'**  
Peter C. Smith  
Hardcover • 8.5 x 11 in  
208 pages • color photos  
136587 AE • 978-1-86126-588-3  
\$49.95 US



**Republic P-47 Thunderbolt**  
**"Bubbletop"**  
Robert Peczkowski  
Paperback • 7 x 10 in  
128 pages • 64 color & 40 b/w photos  
199918 AE • 978-8-36142-127-6  
\$27.00 US/\$29.99 CAN



**Silhouette Handbook**  
**of United States Army**  
**Airforces Airplanes**  
R.M. Clarke  
Paperback • 8.50 x 110 in  
56 pages • color photos  
131503 AE • 978-1-85520-550-5  
\$9.95 US/\$10.95 CAN



**The Sky My Kingdom**  
Memoirs of the Famous German World War II  
Test Pilot  
Hanna Reitch  
Hardcover • 4.75 x 7.5 in  
256 pages • b/w photos  
180961 AE • 978-1-93203-397-7  
\$29.95 US/\$37.50 CAN



**Spitfire Manual 1940**  
Dilip Sarkar  
Paperback • 5 x 8 in  
288 pages • 50 color photos  
193809 AE • 978-1-84868-436-2  
\$19.95 US/\$21.99 CAN



**The Spitfire Story**  
Alfred Price  
Hardcover • 8.25 x 10.5 in  
288 pages • 350 b/w photos  
192433 AE • 978-1-84425-819-2  
\$44.95 US/\$49.99 CAN



**Stormbird Colors**  
Construction, Camouflage and  
Markings of the Me 262  
Brett Green  
Paperback • 8.5 x 11 in  
88 pages • color photos  
139750 AE • 978-0-96607-069-9  
\$30.00 US



**Supermarine Seafire**  
Kev Darling  
Hardcover • 8.75 x 11 in  
192 pages • 230 b/w photos  
146615 AE • 978-1-86126-990-4  
\$44.95 US/\$56.00 CAN



### Owners' Workshop Manual Supermarine Spitfire

1936 onwards (all marks)  
Alfred Price and Paul Blackah  
Hardcover • 8.25 x 10.75 in  
160 pages • 150 color & 30 b/w  
146411 AE • 978-1-84425-462-0  
\$34.95 US/\$39.95 CAN



### Through Blue Skies to Hell

America's "Bloody 100th" in the Air War over Germany  
Edward M. Sion  
Paperback • 6 x 9 in  
256 pages • b/w photos  
199926 AE • 978-1-93514-987-3  
\$18.95 US/\$20.99 CAN



### Through the Eyes of Aces

A Global View of Fighter Pilot's Combat 1939-45  
Robert Jackson  
Hardcover • 6.5 x 9.5 in  
282 pages • 100 b/w photos  
146732 AE • 978-1-84415-421-0  
\$19.95 US



### To War With The Yoxford Boys

The Complete Story of the 357th Fighter Group  
Msgt. Merle Olmsted  
Hardcover • 9 x 11.375 in  
376 pages • 32 color & 527 b/w photos  
139774 AE • 978-0-97210-606-1  
\$64.95 US



### Two-Man Air Force

Don Gentile & John Godfrey: World War II Flying Legends  
Hardcover • 6.50 x 9.50 in  
224 pages • 40 b/w photos  
144916 AE • 978-1-84415-177-6  
\$32.95 US



### U.S. 86th Fighter Group in WWII

Steve W. Luce  
Hardcover • 8.5 x 11 in  
144 pages • 225+ color & b/w photos  
146689 AE • 978-0-97210-608-5  
\$34.95 US



### The USAAF Airman

Service & Survival 1941-45  
Martin J. Brayley  
Hardcover • 8.5 x 12 in  
160 pages • 281 color photos  
146501 AE • 978-1-86126-969-0  
\$34.95 US



### USAAF Fighter Stories

Dramatic accounts of US fighter pilots in training and combat over Europe in the Second World War  
Ian McLachlan  
Hardcover • 6.66 x 9.18 in  
192 pages • 165 b/w photos  
200680 AE • 978-0-85733-227-1  
\$31.95 US/\$34.95 CAN



Available January 2013

### Owners' Workshop Manual Vickers Wellington

1936 to 1953 (all marks and models)  
Iain Murray  
Hardcover • 8.27 x 10.64 in  
160 pages • 60 b/w & 240 color photos  
200702 AE • 978-0-85733-230-1  
\$35.95 US/\$39.95 CAN



### We're Here to Win the War for You

The US 8th Air Force at War  
Martin Bowman  
Paperback • 9.8 x 6 in  
356 pages • 100 photos  
193820 AE • 978-1-84868-429-4  
\$29.95 US/\$32.99 CAN



### When Art Keep 'Em Flying

A Celebration of American Aviation Artists and their Contribution in World War Two  
Georges Grod  
Hardcover • 9 x 12 in  
176 pages • 500 color photos  
199930 AE • 978-2-35250-133-6  
\$44.95 US/\$49.99 CAN



### Wings of the Black Cross Number One

Jerry Crandall  
Paperback • 8.5 x 11 in  
36 pages • 8 color & 69 b/w photos  
139741 AE • 978-0-97210-603-0  
\$17.95 US



### Wings of the Black Cross Number Two

Jerry Crandall  
Paperback • 8.5 x 11 in  
36 pages • 2 color & 60 b/w photos  
139742 AE • 978-0-97210-609-2  
\$17.95 US



### Wings of the Black Cross Number Three

Mark Proulx  
Paperback • 8.5 x 11 in  
250 pages • 20 color & 20 b/w photos  
144019 AE • 978-0-97610-349-3  
\$17.95 US

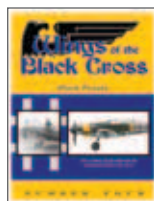

### Wings of the Black Cross Number Four

Mark Proulx and Terry Higgins  
Paperback • 8.5 x 11 in  
250 pages • b/w photos  
149078 AE • 978-0-97940-350-7  
\$17.95 US



### Wings of the Black Cross Number Five

Mark Proulx and Terry Higgins  
Paperback • 8.5 x 11 in  
250 pages • b/w photos  
149079 AE • 978-0-97940-353-8  
\$17.95 US



### Wings of the Black Cross Number Six

Mark Proulx  
Paperback • 8.5 x 11 in  
36 pages • color photos  
150075 AE • 978-0-97940-354-5  
\$17.95 US/\$19.95 CAN



Wings Over The Desert  
In action with an RFC pilot in Palestine 1916-18  
Desmond Seward  
Hardcover • 7.68 x 10.2 in  
224 pages • 150 b/w photos  
150063 AE • 978-1-84425-672-3  
\$34.95 US/\$43.99 CAN



Yellow 10  
Story of the ultra-rare Fw 190 D-13  
Jerry Crandall  
Paperback • 8.5 x 11 in  
88 pages • color photos  
139747 AE • 978-0-96607-063-7  
\$30.00 US



See Page 8

### Warbird Legends

- Represented in this splendid volume are images of the war's 20 greatest aircraft - from the legendary Mustang, Spitfire, Flying Fortress, and Mitsubishi Zero, to lesser-known but equally awe-inspiring warbirds like the Mosquito, Blenheim, and Kingcobra.
- The award-winning air-to-air photography of John Dibbs captures immaculately restored aircraft and is complemented by a selection of archival, frontline images illustrating the true spirit and humanity of these Flying Legends.
- John M. Dibbs spent his childhood near old RAF Command Airfields. His natural interest in aviation has led to a diverse portfolio, and this collection represents his favorite images of World War II aircraft.



See Page 7



"Hell Hawks! is a Stephen Ambrose—  
style history of a 'band of brothers' with  
airplanes...a story that will interest anyone."  
— EAA Warbirds magazine

See Page 7



### The Me 262 Stormbird

- The Me 262 was the world's first operational jet fighter and is one of the most important aircraft of World War II.
- Told largely in the words of German fighter aces who flew the Me 262.
- Includes first-person accounts of American pilots who flew against the Me 262, including several who were able to shoot it down.

### Hell Hawks!

- Robert F. Dorr writes a weekly column for the *Air Force Times* and Thomas D. Jones is a well-known former NASA astronaut who flew four space shuttle missions.
- Little has been written about American fighter-bomber units in World War II. *Hell Hawks!* remedies this by covering the fierce fighting experienced by the 365th Fighter Group from D-Day to VE Day.
- Covers heavy combat in support of Normandy invasion and the Battle of the Bulge.

# AVIATION

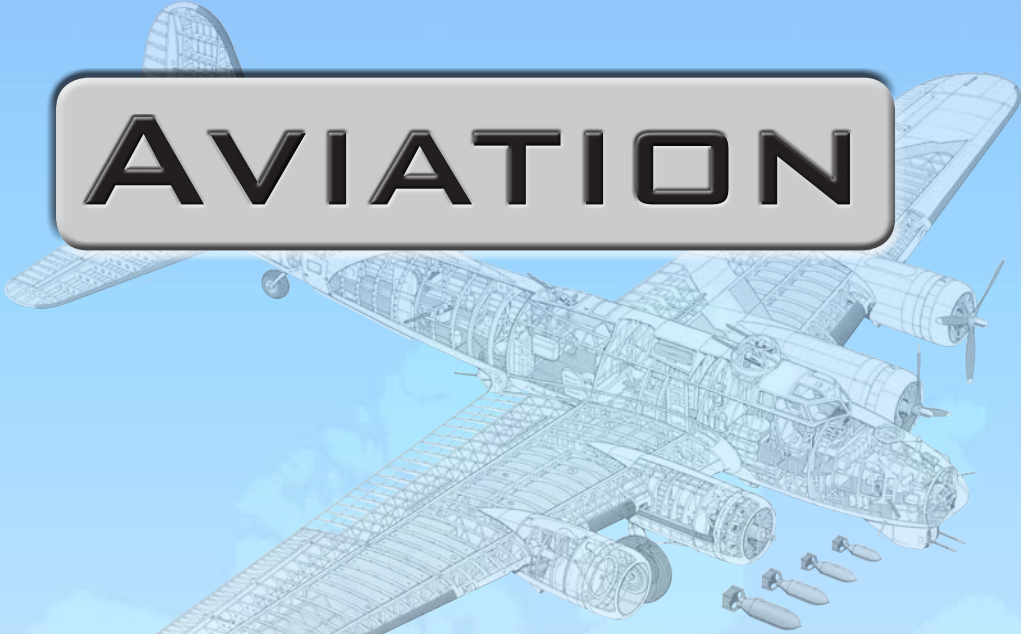

## 60 Years Of Combat Aircraft

From World War One to Vietnam War

Bruno Pautigny

With the 400 profiles and illustrations contained in this book, Bruno Pautigny, the world famous illustrator, paints the technical portraits of the most famous fighters and bombers of all the great conflicts of the previous century: First and Second World Wars, Indochina, Korea and Suez, Algeria, Vietnam, etc.

Hardcover • 9.2 x 12.4 in  
164 pages • 400 color photos  
199870 AE • 978-2-35250-117-6  
\$49.95 US/\$55.00 CAN



## Air Force One

Robert Dorr

This book features a detailed examination of the world's most recognizable airplane, from the interior to the exterior, and everything in between. *Air Force One* also details the history of presidential aircraft, how today's AFI was built, and an examination of its sophisticated communications, navigation, and defensive systems.

Hardcover • 10 x 10 in  
156 pages • 85 color & 40 b/w photos  
134942 AP • 978-0-7603-1055-7  
\$34.95 US/\$38.95 CAN/£21.99 UK



## The Story of the Boeing Company, Updated Edition

Bill Yenne

*The Story of the Boeing Company*, the tale of the plane-maker to the world, unfolds on a fittingly grand scale in this book that is at once the history of one company and the story of an industry. Lavishly illustrated, this book showcases historic aircraft that made the company's name.

Hardcover • 11.25 x 11.25 in  
288 pages • 308 color & 103 b/w photos  
149882 AP • 978-0-7603-4002-8  
\$40.00 US/\$44.00 CAN/£25.00 UK



## Terror of the Autumn Skies

The True Story of Frank Luke, America's Rogue Ace of World War I

Blaine Pardoe

Frantic, short, and splendid, the life of Frank Luke, Jr. dramatizes the tragic intervention of an American spirit in the war that devastated Europe. This book retraces and refreshes the story of this unlikely pilot who, during two torrid weeks in September 1918, was the deadliest man on the Western Front.

Paperback • 6 x 9 in  
336 pages • 39 b/w photos  
200137 AE • 978-1-61608-294-9  
\$16.95 US/\$18.99 CAN

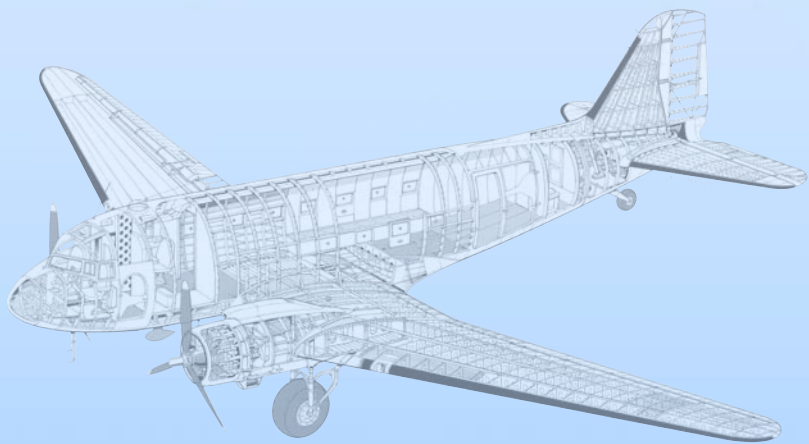

See Page 8

## Vintage Aircraft Nose Art

- Here is an unprecedented collection of the unique art that graced military aircraft in World War II and the Korean War.
- Applied by amateurs or professional artists like Vargas and Brinkman, the art typically featured alluring women whose charms belied the deadly cargo the crew hoped to deliver to its targets. Hundreds of examples are shown in a combination of archival photos from the wars and current photos of artwork in museum collections.
- Fully captioned with aircraft type and unit assignment.



### Aerobatic Teams

Gerard Paloque  
Paperback • 8.2 x 9.7 in  
128 pages • color photos  
199871 AE • 978-2-35250-168-8  
\$29.95 US/\$32.99 CAN



### Air Force

An Illustrated History  
Chester G. Hearn  
Hardcover • 10 x 10 in  
192 pages • 100 color & 80 b/w photos  
145614 AP • 978-0-7603-3308-2  
\$29.95 US/\$32.95 CAN/£18.99 UK



### Avro

The History of an Aircraft Company  
Harry Holmes  
Hardcover • 7.75 x 10 in  
192 pages • color photos  
137525 AE • 978-1-86126-651-4  
\$34.95 US



### Black Fokker Leader

Carl Degelow-The First World War's  
Last Airfight Knight  
Peter Kilduff  
Hardcover • 7 x 10 in  
256 pages • 8 pages b/w photos  
180942 AE • 978-1-90650-228-7  
\$39.95 US/\$49.99 CAN



### British Aircraft Corporation

A History  
Stephen Skinner  
Hardcover • 8.6 x 11 in  
192 pages • 244 color photos  
200563 AE • 978-1-84797-318-4  
\$39.95 US



### Classic Fighters

The Inside Story  
Ray Bonds  
Hardcover • 12.2 x 8.62 in  
256 pages • color photos  
180606 BK • 978-0-78582-785-6  
\$19.99 US/\$21.99 CAN



### Encyclopedia of Soviet Fighters 1939-1951

Histoire & Collections  
Herbert Leonard  
Hardcover • 9.5 x 12.5 in  
192 pages • color photos  
146338 AE • 978-2-91523-960-7  
\$44.95 US

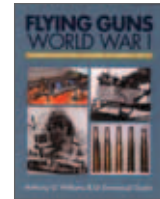

### Flying Guns of World War I

Development of Aircraft Guns, Ammunition and  
Installations 1914-32  
A. G. Williams and Dr. Emmanuel Gustin  
Hardcover • 7.5 x 9.75 in  
192 pages • color photos  
136202 AE • 978-1-84037-396-7  
\$49.95 US



### German & Austrian Aircraft of the First World War

Terry C. Treadwell  
Paperback • 6.8 x 9.6 in  
256 pages • 300 b/w photos  
199891 AE • 978-1-44560-102-1  
\$29.95 US/\$32.99 CAN



### Gladiator Ace

Bill 'Cherry' Vale, the RAF's Forgotten Fighter Ace  
Brian Cull  
Hardcover • 8.25 x 10.75 in  
256 pages • 35 b/w photos  
181062 AE • 978-1-84425-657-0  
\$34.95 US/\$43.99 CAN



### Herman Göring Fighter Ace

Peter Kilduff  
Hardcover • 6.75 x 9.75 in  
224 pages • b/w photos  
193788 AE • 978-1-90650-266-9  
\$39.95 US/\$43.99 CAN



### Immelmann

The Eagle of Lille  
Frantz Immelmann  
Hardcover • 4.8 x 7.5 in  
256 pages • b/w photos  
180962 AE • 978-1-93203-398-4  
\$29.95 US/\$37.50 CAN



### King of Airfighters

The Biography of Major "Mick" Mannock,  
VC, DSO MC  
Ira Jones  
Hardcover • 4.8 x 7.5 in  
256 pages • b/w photos  
180963 AE • 978-1-93203-399-1  
\$29.95 US/\$37.50 CAN



### Knight of Germany

Oswald Bolcke German Ace  
Johannes Werner  
Hardcover • 4.75 x 7.50 in  
256 pages • b/w photos  
193793 AE • 978-1-93514-911-8  
\$29.95 US/\$32.99 CAN



### Leave No Man Behind

The Saga of Combat Search and Rescue  
George Galdorisi and Thomas Phillips  
Hardcover • 6 x 9 in  
656 pages • 16 b/w photos  
140302 AP • 978-0-7603-2392-2  
\$30.00 US/\$32.95 CAN/£16.99 UK



### Mannock

The Life and Death of Major Edward Mannock VC,  
DSO, MC, RAF  
Norman Franks  
Hardcover • 6.75 x 9.50 in  
192 pages • b/w photos  
193796 AE • 978-1-90650-212-6  
\$45.00 US/\$49.99 CAN

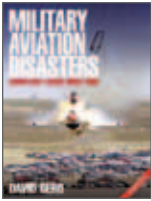

### Military Aviation Disasters

Significant Losses Since 1908  
David Gero  
Hardcover • 7.5 x 10 in  
192 pages • 20 color & 130 b/w photos  
180985 AE • 978-1-84425-645-7  
\$34.95 US/\$43.99 CAN



### Planes of the RAF

Sticker and activity book  
Damian Kelleher, Boyle, Helen and  
Matthew Robson  
Paperback • 8.25 x 11 in  
30 pages • 45 color photos  
146412 AE • 978-1-84425-465-1  
\$8.95 US/\$9.95 CAN



### The Red Baron

A Complete Review in History and Miniature  
Andrea Press  
Paperback • 8.25 x 11.625 in  
72 pages • color photos  
144877 AE • 978-8-49652-733-1  
\$32.95 US



### The Red Baron's Last Flight

An In-Depth Investigation into what Really  
Happened on the Day Von Richthofen was  
Shot Down  
Norman Franks and Alan Bennett  
Paperback • 6.75 x 9.625 in  
144 pages • color photos  
144958 AE • 978-1-90494-333-4  
\$19.95 US

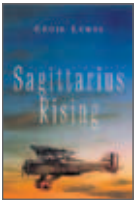

### Sagittarius Rising

Cecil Lewis  
Paperback • 8.25 x 11.75 in  
344 pages • no photos  
193805 AE • 978-1-84832-519-7  
\$29.99 US/\$32.99 CAN



### Gallery Warbirds

John H. Haynes  
Paperback • 6.5 x 8.25 in  
192 pages • 263 color photos  
143025 AP • 978-0-7603-2662-6  
\$17.99 US/\$19.95 CAN/£9.99 UK



### Winged Victory

V.M. Yeates  
Paperback • 5.5 x 8.5 in  
456 pages • color photos  
193821 AE • 978-1-90401-065-4  
\$18.95 US/\$20.95 CAN



### The World's Greatest Aircraft

Christopher Chant  
Hardcover • 11 x 8.5 in  
448 pages • color photos  
180779 BK • 978-0-78582-851-8  
\$24.99 US/\$27.99 CAN



"I found the book fascinating and fun to read, a break from the usual history of military types and their operational careers. It contains everything you could possibly want to know about owning and operating a DC-3, and probably a whole lot more. If you are interested in DC-3's, this is a good book to have. Highly recommended."

— International Plastic Modelers Society

See Page 7



See Page 2



### Douglas DC-3 Dakota Owners' Workshop Manual

- Unique insights into operating and maintaining the legendary Dakota.
- Includes detailed photos of full strip-down and major service.
- Step-by-step photos of engine change.



### North American F-86 Sabre Owners' Workshop Manual

- Includes detailed photos of the rebuilding of an actual F-86.
- Fully illustrated with archive and contemporary photos and official North American technical illustrations.
- Author has flown both the F-86 and its adversary, the MiG-15.

# CIVIL- AVIATION



## Owners' Workshop Manual Aérospatiale-Bac Concorde

1979-2003

David Leney and David McDonald

Concentrating on the technical and engineering aspects of Concorde, this manual provides rare insight into owning, operating, servicing and flying this supersonic airliner. Although the British and French Concorde fleets were prematurely retired in 2003, interest in this marvel of design and technology remains undiminished. Concorde admirers will relish the unique information in this innovative title.

Hardcover • 8.25 x 10.5 in  
160 pages • 200 color & 50 b/w photos  
192426 AE • 978-1-84425-818-5  
\$34.95 US/\$38.99 CAN



## The Alaska Bush Pilot Chronicles

More Adventures and Misadventures from the Big Empty  
Mort D. Mason

More wildly entertaining tales of flying a bush plane in America's final frontier, from the author of Flying the Alaska Wild.

Hardcover • 5.25 x 8 in  
320 pages • 18 b/w photos  
145722 AP • 978-0-7603-3433-1  
\$25.00 US/\$31.99 CAN/£15.99 UK



## Owners' Workshop Manual Boeing 747

1970 onwards (all marks)

Chris Wood

When the Boeing 747 first flew commercially in 1970, it ushered in a new era of affordable air travel. Often referred to by the nickname "Jumbo Jet," it was the world's first wide-body commercial airliner and a major milestone in aviation history. The centerpiece of this Haynes Manual is the bestselling 747-400, which is the model with the most currently in service.

Hardcover • 8.528 x 10.879 in  
160 pages • 250 color & 50 b/w photos  
194819 AP • 978-0-7603-4293-0  
\$28.00 US/\$30.00 CAN



## Boeing 787 Dreamliner

Mark Wagner and Guy Norris

A fascinating behind-the-scenes look at Boeing's new superjumbo—its design, materials, technology, and the drama of making a play for superjumbo supremacy.

Hardcover • 9.25 x 10.875 in  
160 pages • 150 color photos  
144229 AP • 978-0-7603-2815-6  
\$30.00 US/\$32.95 CAN/£20.00 UK



## Cessna 172

A Pocket History

Ron Smith

This small volume traces the origins of the Cessna 172 and highlights the features that have made it so successful. Comprehensively illustrated, with many previously unpublished photographs, the book includes a close-up look at an individual aircraft and highlights the differences between the many Cessna 172 and 175 variants.

Paperback • 4.5 x 6.7 in  
128 pages • 170 color photos  
199882 AE • 978-1-44560-086-4  
\$16.95 US/\$18.99 CAN



## Douglas Propliners

Skyleaders, DC-1 to DC-7

Rene Francillon

Rene J. Francillon's in-depth study of the world's first truly modern airliners is crammed with stunning photographs of Douglas propliners from the golden age of air travel, as well as detailed technical illustrations and full-colour profiles of Douglas aircraft in the airline liveries of the period.

Hardcover • 9.06 x 11.82 in  
360 pages • 200 b/w & 200 color photos  
200678 AE • 978-0-85733-157-1  
\$56.95 US/\$61.95 CAN



## Flying Cars

The Extraordinary History of Cars Designed for Tomorrow's World

Patrick J. Gyger

Cars designed to be flown and aircraft designed to be driven have been created surprisingly often, particularly in the United States, where the unfettered optimism of the 1930s and 1950s allowed such fanciful ideas to flourish from time to time. This handsome book covers the subject in depth for the first time, revealing the stories of many doomed ventures, supported by a wealth of intriguing photography and artwork.

Hardcover • 9 x 11 in  
192 pages • 145 color & 97 b/w photos  
196351 AE • 978-0-85733-091-8  
\$39.95 US/\$43.99 CAN



## Lockheed Constellation

Dominique Breffort

Designed just before World War II, the Lockheed Constellation is celebrated today as one of the finest flying machines ever built. As a civilian aircraft, it has been the first airliner able to cross the Atlantic Ocean non-stop, but it also has had a respectable military career, thanks to its brilliant characteristics which allowed it to fulfill missions of electronic warfare and AWACS.

Hardcover • 9.375 x 12.25 in  
144 pages • color photos  
140390 AE • 978-2-91523-962-1  
\$42.95 US



### Aerobatics

Neil Williams  
Paperback • 5.5 x 8.5 in  
272 pages • color photos  
140056 AE • 978-0-95045-430-6  
\$28.95 US



### Air Traffic Control Handbook

The Complete Guide for all Aviation and Air Band Enthusiasts  
David J. Smith  
Paperback • 6.66 x 9.18 in  
208 pages • 150 b/w photos  
181082 AE • 978-1-84425-832-1  
\$29.95 US/\$37.5 CAN



### Airbus

The Complete Story  
Bill Gunston  
Hardcover • 9 x 11 in  
288 pages • 200 color photos  
150045 AE • 978-1-84425-585-6  
\$52.95 US/\$66.00 CAN



### Airbus A380

Superjumbo of the 21st Century  
Guy Norris and Mark Wagner  
Paperback • 9.125 x 9.125 in  
160 pages • 210 color photos  
149665 AP • 978-0-7603-3838-4  
\$24.99 US/\$27.99 CAN/£16.99 UK



### Airbus A380

Superjumbo on World Tour  
David Maxwell  
Hardcover • 9.25 x 10.875 in  
160 pages • 231 color photos  
145604 AP • 978-0-7603-3279-5  
\$29.95 US/\$35.95 CAN/£18.99 UK



### Autogiro

Rotary Wings Before the Helicopter  
Arthur Ord-Hume  
Hardcover • 8.25 x 11.75 in  
320 pages • 440+ b/w photos  
193773 AE • 978-8-38945-083-8  
\$89.00 US/\$100.00 CAN



### Basic Aerobatics

R. D. Campbell and B. Tempest  
Paperback • 6 x 8.5 in  
160 pages • 70 b/w photos  
114704 AE • 978-1-85310-108-3  
\$28.95 US



### Boeing

The Complete Story  
Alain Pelletier  
Hardcover • 9 x 12 in  
256 pages • 260 color & 250 b/w photos  
192427 AE • 978-1-84425-703-4  
\$44.95 US/\$49.99 CAN



### Boeing 707, KC-135

In Civilian and Military Versions  
Dominique Breffort  
Hardcover • 9.5 x 12.5 in  
212 pages • color photos  
180949 AE • 978-2-35250-075-9  
\$49.95 US/\$55.00 CAN



### Classic Aircraft

Civilian Aviation from 1906 Until the Present Day  
Richard Havers  
Hardcover • 7.75 x 5 in  
128 pages • 120 color photos  
181076 AE • 978-1-84425-707-2  
\$14.95 US/\$18.99 CAN



### Classic American Airlines

Geza Szurovy  
Paperback • 10 x 10 in  
192 pages • 100 color & 80 b/w photos  
136337 AP • 978-0-7603-1656-6  
\$26.95 US/\$32.50 CAN/£16.99 UK



### Concorde

Frédéric Beniada and Michel Fraile  
Hardcover • 15.5 x 10.875 in  
184 pages • 100 color & 50 b/w photos  
143393 AP • 978-0-7603-2703-6  
\$60.00 US/\$78.00 CAN



### Concorde

A Photographic History  
Jonathan Falconer  
Hardcover • 9 x 11 in  
256 pages • 200 color photos  
148979 AE • 978-1-84425-529-0  
\$59.95 US/\$65.00 CAN



### De Havilland Comet

Kev Darling  
Hardcover • 9 x 11.25 in  
200 pages • 20 color & 330 b/w photos  
140137 AE • 978-1-86126-733-7  
\$49.95 US



### Empire Flying Boat Manual

Brian Cassidy  
Hardcover • 8.27 x 10.64 in  
160 pages • 150 b/w & 50 color photos  
200703 AE • 978-0-85733-158-8  
\$35.95 US/\$39.95 CAN

Available February 2013



### Faster Than Sound

The Story of Supersonic Flight  
Bill Gunston  
Hardcover • 8.25 x 10.65 in  
256 pages • 120 color & 120 b/w photos  
148994 AE • 978-1-84425-564-1  
\$49.95 US/\$55.00 CAN



### The Flight of the Mew Gull

Alex Henshaw  
Paperback • 6 x 9 in  
272 pages • 26 b/w photos  
146067 AE • 978-1-84037-021-8  
\$24.95 US



### Flights of Terror

Aerial Hijack and Sabotage Since 1930  
David Gero  
Hardcover • 7.68 x 10.2 in  
192 pages • 20 color & 90 b/w photos  
150041 AE • 978-1-84425-644-0  
\$34.95 US/\$43.99 CAN



### Flying Helicopters

A Companion to the PPL(H)  
Helen Krasner  
Paperback • 6 x 9.25 in  
128 pages • 66 color photos  
200105 AE • 978-1-84797-271-2  
\$19.95 US/\$21.99 CAN



### Flying the Airbus A380

Captain Gib Vogel  
Paperback • 6.2 x 9.25 in  
128 pages • 130 color photos  
181004 AE • 978-1-84797-124-1  
\$22.95 US/\$28.99 CAN



### Flying the Big Jets

Flying the Boeing 777 4th Edition  
Stanley Stewart  
Paperback • 6 x 9 in  
292 pages • 131 b/w photos  
195070 AE • 978-1-84037-422-3  
\$34.95 US/\$38.99 CAN



### The Helicopter Pilot's Companion

A Manual for Helicopter Enthusiasts  
Helen Krasner  
Paperback • 6.25 x 9.25 in  
160 pages • 28 color photos  
147820 AE • 978-1-84797-049-7  
\$22.95 US

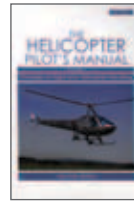

### The Helicopter Pilot's Manual

Principles of Flight and Helicopter Handling  
Norman Bailey  
Paperback • 6 x 8.5 in  
256 pages • color photos  
146506 AE • 978-1-86126-982-9  
\$34.95 US



### The Helicopter Pilot's Manual Volume 2

Powerplants, Instruments and Hydraulics  
Norman Bailey  
Paperback • 6.25 x 8.5 in  
152 pages • 92 b/w photos  
146614 AE • 978-1-86126-991-1  
\$34.95 US



### The Helicopter Pilot's Manual Volume 3

Mountain Flying and Advanced Techniques  
Norman Bailey  
Paperback • 6 x 9.25 in  
96 pages • color photos  
150167 AE • 978-1-84797-105-0  
\$24.95 US/\$31.99 CAN



### Motorbooks Studio How to Draw and Paint Aircraft Like a Pro

Andrew Whyte and Charlie Cooper  
Paperback • 8.25 x 10.625 in  
160 pages • 158 color & 83 b/w photos  
145677 AP • 978-0-7603-3391-4  
\$24.99 US/\$27.50 CAN/£14.99 UK



### Jet Engines

Fundamentals of Theory, Design and Operation  
Klaus Hunecke  
Hardcover • 6 x 9 in  
224 pages • 180 b/w photos  
191590 AE • 978-1-85310-834-1  
\$34.95 US



### Meteorology For Pilots

Mike Wickson  
Paperback • 6 x 8.5 in  
340 pages • 20 color & 186 b/w photos  
140066 AE • 978-1-84037-284-7  
\$34.95 US



### Microlight Pilot's Handbook

Brian Cosgrove  
Paperback • 7.5 x 9.5 in  
168 pages • 178 color & 50 b/w photos  
140067 AE • 978-1-84037-286-1  
\$34.95 US



### The Naked Pilot

The Human Factor in Aircraft Accidents  
David Beaty  
Paperback • 6 x 8.5 in  
328 pages • 31 b/w photos  
121110 AE • 978-1-85310-482-4  
\$18.95 US/\$23.99 CAN



### Paramotoring From The Ground Up

A Comprehensive Guide  
Noel Whittall  
Paperback • 7.5 x 9.75 in  
192 pages • 95 color & 36 b/w photos  
147818 AE • 978-1-84797-053-4  
\$34.95 US



### Pilot's Weather

Brian Cosgrove  
Hardcover • 6.25 x 9.5 in  
192 pages • color photos  
140070 AE • 978-1-84037-027-0  
\$29.95 US



### Schneider Trophy to Spitfire

The Design Career of R.J. Mitchell  
John Shelton  
Hardcover • 8.25 x 10.65 in  
256 pages • 16 color & 100 b/w photos  
148976 AE • 978-1-84425-530-6  
\$49.95 US/\$55.00 CAN



### The Soaring Pilot's Manual

Second Edition  
Ken Stewart  
Paperback • 6.25 x 8.5 in  
400 pages • 300 b/w photos  
147817 AE • 978-1-84797-044-2  
\$34.95 US

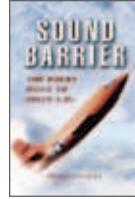

### Sound Barrier

The Rocky Road to MACH 1.0+  
Peter Caygill  
Hardcover • 6.5 x 9.5 in  
224 pages • 60 b/w photos  
146250 AE • 978-1-84415-456-2  
\$39.95 US



### Stars of the Sky, Legends All

Illustrated Histories of Women Aviation Pioneers  
Ann Lewis Cooper, Sharon Rajnus, Deb Coonts and Stephen Coonts  
Paperback • 9.25 x 10.875 in  
160 pages • 120 color & 50 b/w photos  
145662 AP • 978-0-7603-3374-7  
\$24.95 US/\$27.95 CAN/£16.99 UK



### Successful Composite Techniques

A practical introduction to the use of modern composite materials  
Keith Noakes  
Paperback • 8.5 x 11 in  
176 pages • 220 b/w photos  
147819 AE • 978-1-84797-054-1  
\$29.95 US



### To Be A Pilot

Ian Penberthy  
Paperback • 6.25 x 9.25 in  
176 pages • 30 color photos  
147815 AE • 978-1-84797-013-8  
\$22.95 US



### To Be an Airline Pilot

Andrew Cook  
Paperback • 6.5 x 9.25 in  
160 pages • 25 b/w photos  
145107 AE • 978-1-86126-865-5  
\$22.95 US



### The World's Top 500 Airports

David Wragg  
Hardcover • 6.5 x 9 in  
416 pages • 250 color & 250 b/w photos  
181057 AE • 978-1-84425-632-7  
\$52.95 US/\$66.00 CAN

## PRIVATE PILOT



### Aircraft Inspection and Repair

Federal Aviation Administration  
Paperback • 8.5 x 11 in  
768 pages • 200 b/w photos  
192759 AE • 978-1-60239-950-1  
\$24.95 US/\$31.99 CAN



### Airplane Flying Handbook

Federal Aviation Administration  
Paperback • 8.5 x 11 in  
288 pages • color photos  
146297 AE • 978-1-60239-003-4  
\$16.95 US/\$21.50 CAN



### Aviation Instructor's Handbook

FAA-H-8083-9A  
Federal Aviation Administration  
Paperback • 8.5 x 11 in  
160 pages • 100 b/w photos  
192866 AE • 978-1-60239-777-4  
\$14.95 US/\$18.99 CAN



### Aviation Weather Services Handbook

Federal Aviation Administration  
Paperback • 8.5 x 11 in  
216 pages • b/w photos  
192762 AE • 978-1-60239-944-0  
\$19.95 US/\$24.99 CAN



### Aviation Weather Services Handbook 2nd Edition

Federal Aviation Administration  
Paperback • 8.5 x 11 in  
400 pages • b/w color photos  
192761 AE • 978-1-60239-065-2  
\$12.95 US/\$16.50 CAN

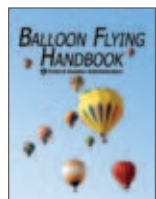

### Balloon Flying Handbook

Federal Aviation Administration  
Paperback • 8.5 x 11 in  
128 pages • 10 b/w photos  
192763 AE • 978-1-60239-069-0  
\$12.95 US/\$16.50 CAN

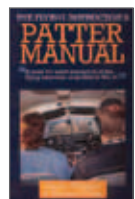

### The Flying Instructor's Patter Manual

A word for word account of all the flying exercises as spoken in the air  
Peter Phillips and Robert Cole  
Paperback • 5.4375 x 8.5 in  
304 pages • 98 b/w photos  
145097 AE • 978-1-86126-840-2  
\$34.95 US



### The Glassfibre Handbook

R. H. Warring  
Paperback • 5.75 x 8.25 in  
160 pages • color photos  
134877 AE • 978-0-85242-820-7  
\$11.95 US



### Glider Flying Handbook

Federal Aviation Administration

Paperback • 8.5 x 11 in

240 pages • color photos

192768 AE • 978-1-60239-061-4

\$24.95 US/\$31.99 CAN



### Instrument Procedures Handbook

Federal Aviation Administration

Paperback • 8.5 x 11 in

296 pages • 300 color photos

192774 AE • 978-1-60239-261-8

\$19.95 US/\$24.99 CAN

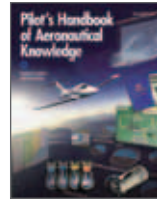

### Pilot's Handbook of Aeronautical Knowledge

Federal Aviation Administration

Paperback • 8.5 x 11 in

352 pages • 300 color & 100 b/w photos

192779 AE • 978-1-60239-780-4

\$24.95 US/\$31.99 CAN

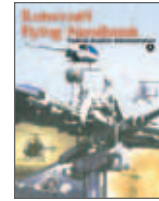

### Rotorcraft Flying Handbook

Federal Aviation Administration

Paperback • 8.5 x 11 in

208 pages • 500 color photos

192781 AE • 978-1-60239-997-6

\$14.95 US/\$18.99 CAN



See Page 18

### Boeing 747 Owners' Workshop Manual

- Features detailed photos of servicing and maintenance.
- Includes specially commissioned photography of the 747-400.
- The author is an experienced 747 pilot.

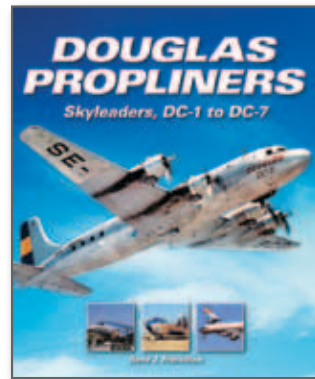

See Page 18



### Douglas Propliners

- Comprehensive illustrated history of the Douglas DC-1 to DC-7 series, the world's first modern airliners.
- The book for Douglas prop-liner enthusiasts lavishly illustrated with photographs and drawings.
- Detailed appendices give full production details, fuselage serial numbers, constructor numbers and initial customers (including military variants).

# SPACE



## Burt Rutan's Race to Space

The Magician of Mojave and His Flying Innovations  
Dan Linehan and Mike Melvill

*Burt Rutan's Race to Space* showcases Rutan's efforts and most celebrated achievements, including SpaceShipOne, which won the coveted \$10 million Ansari X Prize for private spaceflight; the Voyager, the Virgin Atlantic GlobalFlyer, and the VariEze.

Hardcover • 9.5 x 11.125 in  
160 pages • 177 color & 48 b/w photos  
149639 AP • 978-0-7603-3815-5  
**\$30.00 US/\$33.00 CAN/£20.00 UK**



## Owners' Workshop Manual NASA Apollo 11

1969 (including Saturn V, SM-107, SM-107, LM-5)  
Christopher Riley and Philip Dolling

On July 20, 1969, US astronaut Neil Armstrong became the first man to walk on the moon. This is the story of the Apollo 11 mission and the 'space hardware' that made it all possible.

Hardcover • 8.27 x 10.64 in  
160 pages • 175 color & 25 b/w photos  
150071 AE • 978-1-844-25683-9  
**\$34.95 US/\$38.99 CAN**



## Owners' Workshop Manual NASA Space Shuttle

1981 onwards (all models)  
David Baker

David Baker describes the origin of the reusable launch vehicle concept during the 1960s, its evolution into a viable flying machine, and its subsequent design, engineering, and operation. The Shuttle's internal layout and systems are explained as well as avionics systems.

Hardcover • 8.5 x 10.875 in  
160 pages • 200 color & 50 b/w photos  
193313 AP • 978-0-7603-4076-9  
**\$28.00 US/\$30.00 CAN**



## One Giant Leap

Apollo 11 Remembered  
Piers Bizony

A spectacular visual record of the first moon landing, with an essay by space historian Piers Bizony and commentary from astronauts, scientists, and contemporary pundits.

Hardcover • 8.976 x 10.236 in  
160 pages • 200 color photos  
147284 AP • 978-0-7603-3710-3  
**\$35.00 US/\$43.99 CAN**



## The Space Shuttle

Celebrating Thirty Years of NASA's First Space Plane  
Piers Bizony

This superbly designed and lavishly illustrated book marks a special moment in history: the final mission of the space shuttle. Noted space and science author Piers Bizony has put together a retrospective that covers the entire space shuttle program.

Hardcover • 10.5 x 11.25 in  
300 pages • 900 color photos  
149788 AP • 978-0-7603-3941-1  
**\$40.00 US/\$44.00 CAN/£27.50 UK**



## SpaceShipOne

An Illustrated History  
Dan Linehan and Sir Arthur C. Clarke

This behind-the-scenes book chronicles the development of the world's first commercial manned space program-- from design to deal-making to launch.

Paperback • 9.25 x 10.875 in  
160 pages • 295 color photos  
149871 AP • 978-0-7603-3988-6  
**\$24.99 US/\$27.99 CAN/£16.99 UK**  
Hardcover  
144429 AP • 978-0-7603-3188-0  
**\$34.95 US/\$38.50 CAN/£25.00 UK**



"Are you looking for this year's biggest, shiniest coffee-table book about NASA's recently departed space shuttle fleet? Bizony's book is chock-full of pictures from each of the fleet's 135 missions, although the last one is represented only by a picture of Atlantis and its team during preparations for July's final flight. The text reviews 30 years of highs and lows for the shuttle program."

— Alan Boyle, Cosmic Logic, MSNBC

See Above



## The Space Shuttle

- Lavishly illustrated with spectacular photographs.
- By well-known space and science author Piers Bizony.



## Advanced Aviation Modelling

John McIlmurray  
 Paperback • 7.4375 x 9.6875 in  
 160 pages • 337 color photos  
**144667 AE • 978-1-86126-753-5**  
**\$29.95 US**



## Flying Radio-Controlled Model Aircraft

Colin Bedson  
 Paperback • 6.5 x 9.25 in  
 128 pages • 15 color photos  
**145932 AE • 978-1-86126-915-7**  
**\$22.95 US**



## Owners' Workshop Manual International Rescue Thunderbirds

1964 Onwards (All Marks and Models)  
 Sam Denham and Graham Bleathman  
 Hardcover • 8.25 x 10.6 in  
 128 pages • 150 color photos  
**200185 AE • 978-0-85733-117-5**  
**\$24.95 US/\$27.99 CAN**



## P-40 Curtiss

Assembly, Transformation, Painting, Weathering  
 Olivier Souley's  
 Paperback • 8 x 9.5 in  
 84 pages • color photos  
**199938 AE • 978-2-35250-065-0**  
**\$19.95 US/\$21.99 CAN**



## Radio Control Foam Modelling

David Thomas  
 Paperback • 5.75 x 8.25 in  
 176 pages • color photos  
**134879 AE • 978-1-85486-179-5**  
**\$11.95 US**



## Radio Controlled Helicopters -2 Edition

The Guide to Building and Flying R/C Helicopters  
 Nick Papillon  
 Paperback • 5.75 x 8.25 in  
 170 pages • 73 b/w photos  
**136858 AE • 978-1-85486-226-6**  
**\$20.95 US**



## Scale Aircraft for Free Flight

Eric Coates  
 Paperback • 5.75 x 8.25 in  
 128 pages • color photos  
**134875 AE • 978-1-85486-167-2**  
**\$10.95 US**



## Scale Aircraft Modelling

Mark Stanton  
 Paperback • 7.5 x 9.5 in  
 176 pages • color photos  
**135563 AE • 978-1-861264-45-9**  
**\$29.95 US**



## Scale Military Figure Conversions

Duncan Howarth  
 Paperback • 7.44 x 9.69 in  
 192 pages • 560 color photos  
**149454 AE • 978-1-84797-067-1**  
**\$29.95 US/\$32.95 CAN**



## Scale Military Vehicle Conversions

Duncan Howarth  
 Paperback • 7.4375 x 9.6875 in  
 160 pages • 320 color photos  
**145922 AE • 978-1-86126-888-4**  
**\$29.95 US**



## Take Off

All about Radio Controlled Model Aircraft  
 Alex Weiss  
 Paperback • 7.25 x 9.25 in  
 256 pages • color photos  
**134889 AE • 978-1-85486-166-5**  
**\$20.95 US**



## Terrain Modeling

Richard Windrow  
 DVD • 5 x 7 in  
 90 minutes running time  
**146816 AE • 978-1-90557-397-4**  
**\$24.95 US**



## The Vintage Years of Airfix Box Art

Roy Cross  
 Hardcover • 11 x 11 in  
 128 pages • 180 color photos  
**150160 AE • 978-1-84797-076-3**  
**\$59.95 US/\$75.00 CAN**

# SHIPS



## Owners' Workshop Manual

### HMS Victory

1765-1812

Peter Goodwin

Maritime historian and former HMS Victory Keeper and Curator Peter Goodwin tells the story of the most famous surviving historic warship in the world today, giving fascinating insights into how she was built, her anatomy and weaponry, and how a ship of the line in the Georgian navy was sailed, fought and maintained.

Hardcover • 8.25 x 10.6 in

160 pages • 250 color & 50 b/w photos

200183 AE • 978-0-85733-085-7

\$29.95 US/\$32.99 CAN

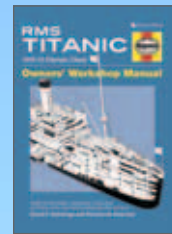

## Owners' Workshop Manual

### RMS Titanic

1909-1912 (Olympic Class)

David Hutchings and Richard de Kerbrech

See how the world famous ocean liner Titanic was built, launched and fitted out; read about her lavish passenger accommodation; and learn about the captain's responsibilities, including the operation of a transatlantic liner. Includes hundreds of illustrations.

Hardcover • 8.5 x 10.875 in

160 pages • 200 color & 50 b/w photos

193316 AP • 978-0-7603-4079-0

\$28.00 US/\$30.00 CAN



## Seapower

John Gresham and Ian Westwell

A spectacular arrangement of photographs highlights the 26 classes plus 8 other types of vessels represented here, with complete specifications and histories.

Hardcover • 11 x 7.75 in

256 pages

160115 BK • 978-0-78582-462-6

\$12.99 US/\$14.99 CAN



## Owners' Workshop Manual

### SS Great Britain

1843-1937

An Insight into the Design, Construction and Operation of Brunel's Famous Passenger Ship

Brian Lavery

The SS Bristol, a world first with new technologies, was built in 1843, went around the world 37 times, retired 1889 and now resides back home in Bristol, England where today she is conserved. Now, her innovative technology is explained in this Haynes manual.

Hardcover • 8.25 x 10.6 in

160 pages • 250 color photos

200181 AE • 978-0-85733-105-2

\$29.95 US/\$32.99 CAN

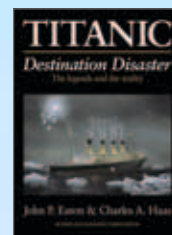

## Titanic: Destination Disaster

The Legends and the Reality Revised and Expanded Third Edition

John P. Eaton and Charles A. Haas

This affordable paperback is unrivalled as an introduction to the Titanic which has been fully updated in a centenary edition and expertly summarizes the whole Titanic story, from building and launching, through the glory days and sinking, to the discovery of the wreck by an unmanned submersible and the subsequent crewed dives.

Paperback • 6.25 x 8.5 in

223 pages • 16 color & 162 b/w photos

199753 AE • 978-0-85733-025-3

\$19.95 US/\$21.99 CAN



## U.S. Navy SEALs

- Updated and expanded to include the bin Laden mission, operations in Afghanistan, and fighting pirates off Somalia.
- Special operations continues to be a hot topic.
- Previous editions have sold more than 24,000 copies.

"Hans Halberstadt has written extensively on U.S. special operations forces. A talented photographer, he took most of the photos in this book. *U.S. Navy SEALs* is a good overview of the Navy's special operations branch. It is a particularly good source of information on the organizations current-day training and equipment."

—Military Trader



See Page 46

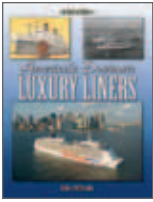

### America's Postwar Luxury Liners

John A. Fostik  
Paperback • 8.5 x 11 in  
128 pages • 40 color & 160 b/w photos  
196312 AE • 978-1-58388-287-0  
\$34.95 US/\$38.99 CAN



### Classic Ships

Richard Havers  
Hardcover • 7.75 x 5 in  
128 pages • 120 color photos  
181077 AE • 978-1-84425-708-9  
\$14.95 US/\$18.99 CAN



### The Illustrated Directory of Warships

From 1860 to the Present  
David Miller  
Paperback • 4.5 x 8.5 in  
480 pages • 300 color photos  
133043 AP • 978-0-7603-1127-1  
\$15.95 US/\$17.95 CAN/£9.99 UK

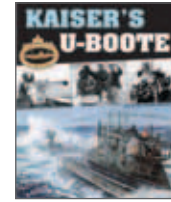

### Kaiser's U-Boote

Editors of Histoire & Collections  
Hardcover • 10 x 12.5 in  
192 pages • color photos  
140094 AE • 978-2-91390-396-8  
\$44.95 US/\$49.99 CAN



### Gallery Modern Warships

Kit Bonner and Carolyn Bonner  
Paperback • 6.5 x 8.25 in  
192 pages • 219 color & 33 b/w photos  
144366 AP • 978-0-7603-2950-4  
\$14.95 US/\$18.95 CAN/£9.99 UK



### So Terrible a Storm

A Tale of Fury on Lake Superior  
Curt Brown  
Paperback • 6 x 9 in  
320 pages • 34 b/w photos  
149890 AP • 978-0-7603-4012-7  
\$14.99 US/\$16.99 CAN/£10.99 UK



### Titanic Triumph and Tragedy

Third Edition  
John P. Eaton, Charles A. Haas and William H. Miller Jr.  
Hardcover • 9 x 12 in  
416 pages • 16 color & 1100 b/w photos  
199754 AE • 978-0-85733-024-6  
\$49.95 US/\$55.00 CAN



### Titanic

The Unfolding Story as told by *The Daily Mirror*  
Richard Havers  
Hardcover • 10 x 10 in  
208 pages • 75 color photos  
200100 AE • 978-0-85733-167-0  
\$29.95 US/\$32.95 CAN

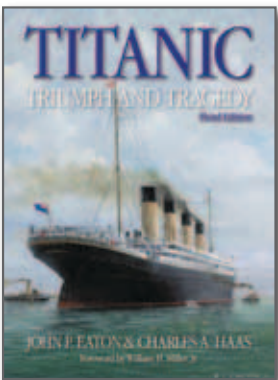

"A must-have for anyone interested in Titanic; worth updating to this new edition."  
— *Library Journal*

See Above

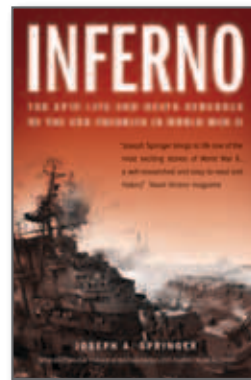

"Joseph Springer brings to life one of the most exciting stories of World War II as seen and told from the perspective of the officers and sailors who served on board the Essex-class aircraft carrier USS Franklin."  
— *Washington Times*

See Page 41



### Titanic Triumph and Tragedy

- Tourist dives, management takeover at RMS Titanic Inc, salvor-in-possession of wreck and artifacts, continuing exploration and documentation of the wreck by RMS Titanic, Inc., James Cameron, and others.
- Appeals Court ruling on ownership of artifacts, effectively blocking their sale including submissions to US Congress of enabling legislation for 'Titanic Maritime Memorial Preservation Act', setting standards for future artifact recovery.
- Since 1999, as investigations continue in their several guises, facts hitherto-unknown about Titanic appear, important details of older facts are added or modified. Additional pictures have emerged of recent and ongoing events, illustrating new aspects of the ship's story.

### Inferno

- The story of the Franklin is one of the most dramatic in naval history.
- Books like *In Harm's Way*, about the loss of the USS Indianapolis, show a strong market for this kind of sea story.
- Comprehensive research answers the lingering questions about the event.

# MILITARY

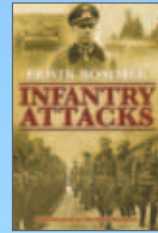
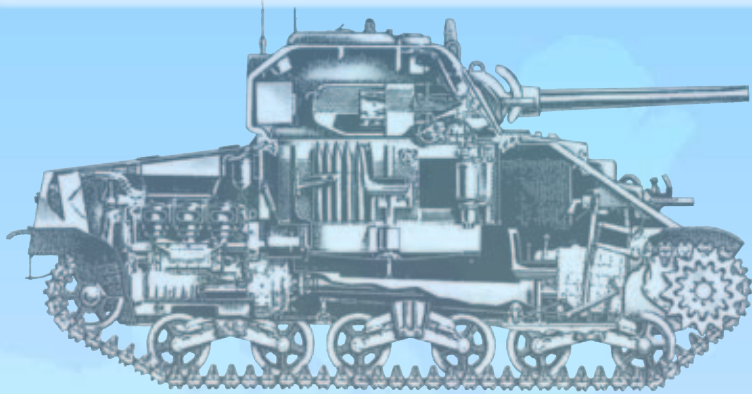

## Infantry Attacks

Field Marshal Erwin Rommel and Manfred Rommel  
Field Marshal Erwin Rommel exerted influence over not only his troops, but also the Allied soldiers of the Eighth Army in World War II. In this 1935 title, he recalls his greatest battles, outlines how he won them, and provides his strategies on the use of armor in the field—lessons ultimately used by Patton and other Allied tank commanders to defeat him.

Paperback • 6 x 9 in  
288 pages • color photos  
147227 AP • 978-0-7603-3715-8  
\$19.99 US/\$24.99 CAN

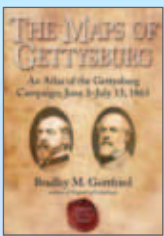

## The Maps of Gettysburg

An Atlas of the Gettysburg Campaign, June 3 - July 13, 1863  
Bradley M. Gottfried

*The Maps of Gettysburg* breaks down the entire operation into thirty map sets or "action-sections" enriched with 144 detailed, full-page color maps comprising the entire campaign.

Hardcover • 7 x 10 in  
384 pages • color photos  
199909 AE • 978-1-93271-482-1  
\$39.95 US/\$43.99 CAN

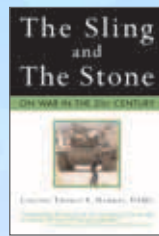

## The Sling and the Stone

On War in the 21st Century  
Colonel Thomas X. Hammes, USMC

Col. Hammes discusses how the ongoing events in Iraq show how difficult it is for the world's only remaining superpower to impose its will upon other peoples, and cites other recent incidents of powerful military forces being tied up by seemingly weaker opponents.

Hardcover • 6.25 x 9.375 in  
336 pages • color photos  
138678 AP • 978-0-7603-2059-4  
\$26.95 US/\$33.95 CAN/£16.99 UK  
Paperback  
140453 AP • 978-0-7603-2407-3  
\$17.99 US/\$19.99 CAN/£12.99 UK



## Survive the Bomb

The Radioactive Citizen's Guide to Nuclear Survival  
Eric G. Swedin

Attention, citizens and fellow travelers of the Cold War: *Survive the Bomb* is your family's ultimate fallout shelter companion. Keep this book at the ready next to the emergency drinking water and vacuum-packed canned meats and vegetables for that moment when the saber-rattling between the world's superpowers turns Atomic. Don't let a little thing like an atomic particle spoil your day!

Hardcover • 5.25 x 7.75 in  
192 pages • 1 color & 138 b/w photos  
149927 AP • 978-0-7603-4031-8  
\$17.00 US/\$19.00 CAN/£14.99 UK

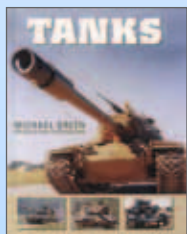

## Tanks

Michael Green, James D. Brown and Christophe Vallier  
A lavishly illustrated guide to tanks, from their beginning in World War I through the marvels of modern digital technology encased in armor that make up the tank fleets of many of today's armies.

Paperback • 6.5 x 8.25 in  
192 pages • 208 color & 52 b/w photos  
145641 AP • 978-0-7603-3351-8  
\$16.99 US/\$18.99 CAN/£9.99 UK

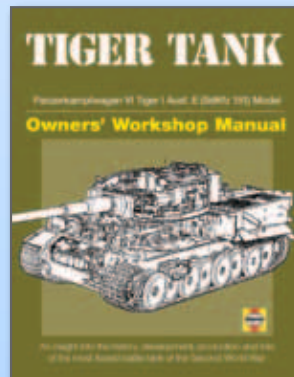

## Tiger Tank Owners' Workshop Manual

- Successful Haynes Manual format, part of a series with Spitfire and Lancaster manuals.
- Centered on Bovington's fully restored Tiger I (Tiger 131) and published in association with the Bovington Tank Museum.
- Tiger 131 is the world's only Tiger I in running order.

"Tiger Tank is jam-packed with photos, both of the subject tank and historical views. It's the next best thing to crawling over one yourself."

— Model Retailer



See Page 37



### The Art Of War

Sun Tzu  
Hardcover • 5.25 x 7.3125 in  
128 pages •  
**159643 BK • 978-0-78582-451-0**  
**\$8.99 US**  
Paperback  
**180389 BK • 978-0-78582-687-3**  
**\$9.99 US**

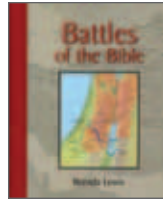

### Battles of the Bible

Ian Barnes  
Hardcover • 6.64 x 8.125 in  
224 pages  
**157534 BK • 978-0-78582-527-2**  
**\$12.99 US/\$14.99 CAN**



### Bristol's Bastards

In Iraq with the 2nd Battalion, 136th Infantry of Minnesota's National Guard  
Nick Maurstad and Darwin Holmstrom  
Hardcover • 6 x 9 in  
320 pages • 152 b/w photos  
**145602 AP • 978-0-7603-3277-1**  
**\$26.00 US/\$28.95 CAN/£15.99 UK**



### The Building

A Biography of the Pentagon  
David Alexander  
Hardcover • 6 x 9 in  
400 pages • 33 b/w photos  
**139388 AP • 978-0-7603-2087-7**  
**\$28.00 US/\$29.95 CAN/£16.99 UK**

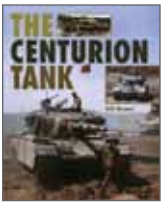

### The Centurion Tank

Bill Munro  
Hardcover • 7.5 x 9.75 in  
192 pages • 125 b/w photos  
**140136 AE • 978-1-86126-701-6**  
**\$34.95 US/\$43.99 CAN**



### The Civil War Day By Day

Phillip Katcher  
Hardcover • 8.5 x 11 in  
192 pages • color photos  
**180359 BK • 978-0-78582-664-4**  
**\$12.99 US/\$14.99 CAN**



### The Clausewitz Delusion

How the American Army Screwed Up the Wars in Iraq and Afghanistan (A Way Forward)  
Stephen L. Melton  
Hardcover • 6 x 9 in  
320 pages • color photos  
**147286 AP • 978-0-7603-3713-4**  
**\$30.00 US/\$37.50 CAN/£18.99 UK**



### A Cold War Legacy

A Tribute to the Strategic Air Command, 1946-1992  
Alwyn Lloyd  
Hardcover • 8.75 x 11.25 in  
704 pages • 16 color & 850 b/w photos  
**129961 AE • 978-1-57510-052-4**  
**\$55.00 US**



### The Cold War

An Illustrated History  
Andrew Heritage  
Paperback • 5 x 7.8 in  
384 pages • 15 color & 20 b/w photos  
**193730 AE • 978-1-84425-949-6**  
**\$32.95 US/\$35.99 CAN**

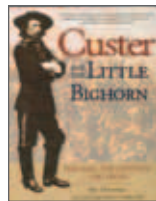

### Custer and the Little Bighorn

The Man, The Mystery, The Myth  
Jim Donovan  
Hardcover • 8.75 x 11.25 in  
224 pages • color photos  
**157752 BK • 978-0-78582-589-0**  
**\$12.99 US/\$14.99 CAN**



### The Encyclopedia of Civil War Usage

Webb Garrison and Cheryl Garrison  
Hardcover • 7.25 x 9.25 in  
274 pages  
**157490 BK • 978-0-78582-346-9**  
**\$9.99 US/\$10.99 CAN**



### FBI 100 Years

An Unofficial History  
Henry M. Holden  
Hardcover • 10.50 x 12 in  
252 pages • 135 color & 165 b/w photos  
**145373 AP • 978-0-7603-3244-3**  
**\$40.00 US/\$44.00 CAN/£25.00 UK**



### First Bull Run

First Victory for the South  
Pascal Le Pautremat  
Paperback • 7.8 x 9.2 in  
80 pages • 69 b/w photos  
**199888 AE • 978-2-35250-153-4**  
**\$19.95 US/\$21.99 CAN**



### The German Soldier 1914-1918

Jean-Claude Laparra  
Paperback • 8 x 9.5 in  
68 pages • 150 photos  
**193813 AE • 978-2-35250-071-1**  
**\$19.95 US/\$24.99 CAN**



### The German Wars

A Concise History, 1859-1945  
Michael A. Palmer  
Hardcover • 5.75 x 8.75 in  
256 pages • 12 b/w photos  
**149592 AP • 978-0-7603-3780-6**  
**\$29.00 US/\$32.00 CAN/£20.00 UK**



### The Half-Ton Military Land Rover

Mark Cook  
Paperback • 8.25 x 9.75 in  
192 pages • 57 color & 140 b/w photos  
**137034 AE • 978-1-90370-696-1**  
**\$49.95 US/\$55.00 CAN**



### The Historical Atlas of the World At War

Brenda Lewis and Rupert Matthews  
Hardcover • 10 x 13 in  
400 pages  
157465 BK • 978-0-78582-486-2  
\$29.99 US/\$32.99 CAN  
Paperback • 7.5 x 10 in  
180542 BK • 978-0-78582-745-0  
\$14.99 US/\$16.99 CAN



### The KGB's Poison Factory

From Lenin to Litvinenko  
Boris Volodarsky  
Hardcover • 6 x 9 in  
256 pages • 42 b/w photos  
149564 AP • 978-0-7603-3753-0  
\$25.00 US/\$31.99 CAN



### The Last Confederate General

John C. Vaughn and His East Tennessee Cavalry  
Larry Gordon  
Hardcover • 5.5 x 8.5 in  
272 pages • 23 b/w photos  
145804 AP • 978-0-7603-3517-8  
\$27.00 US/\$33.95 CAN/£17.99 UK



### Lincoln's Admiral

The Civil War Campaigns of David Farragut  
James P. Duffy  
Hardcover • 6.13 x 9.25 in  
288 pages  
159394 BK • 978-0-78582-096-3  
\$9.99 US/\$10.99 CAN

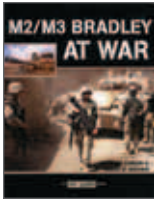

### At War M2/M3 Bradley at War

Michael Green and James D. Brown  
Paperback • 8.25 x 10.625 in  
128 pages • 124 color & 15 b/w photos  
143026 AP • 978-0-7603-2523-0  
\$19.95 US/\$21.95 CAN/£12.99 UK



### Main Battle Tanks

Youri Obraztsov  
Hardcover • 5.5 x 7.75 in  
128 pages • 350 color photos  
193795 AE • 978-2-35250-138-1  
\$22.95 US/\$32.95 CAN



### Matthew B. Brady

America's First Great Photographer  
Wayne Youngblood  
Hardcover • 16.50 x 11.75 in  
256 pages  
159935 BK • 978-0-78582-322-3  
\$29.99 US/\$32.99 CAN

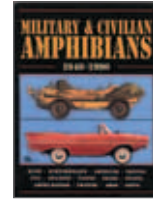

### Military & Civilian Amphibians 1940-90

R.M. Clarke  
Paperback • 8 x 10.75 in  
100 pages • 180 b/w photos  
120871 AE • 978-1-85520-251-1  
\$24.95 US/\$27.5 CAN



### Enthusiasts' Manual Military Land Rover

1948 Onwards (Series II/IIA to Defender)  
Pat Ware  
Hardcover • 8.25 x 10.5 in  
160 pages • 250 color & 50 b/w photos  
196370 AE • 978-0-85733-080-2  
\$29.95 US/\$32.99 CAN



### Stereoscope Native Americans & the Wild West in 3D: A Look Back in Time

With Built-in Stereoscope Viewer-Your Glasses to the Past!  
Greg Dinkins  
Hardcover • 7 x 10 in  
96 pages • 45 b/w photos  
147294 AP • 978-0-7603-3725-7  
\$19.99 US/\$24.99 CAN/£12.99 UK



### The Nuclear Express

A Political History of the Bomb and Its Proliferation  
Thomas C. Reed and Danny B. Stillman  
Hardcover • 6 x 9 in  
400 pages • 40 b/w photos  
145788 AP • 978-0-7603-3502-4  
\$30.00 US/\$32.95 CAN/£17.99 UK  
Paperback  
149770 AP • 978-0-7603-3904-6  
\$19.99 US/\$21.99 CAN/£14.99 UK



### Outdoor Survival

A Step-by-Step Guide to Practical Bush Craft and Survival Outdoors  
David Pearce  
Hardcover • 8.25 x 10.6 in  
176 pages • 250 color photos  
193954 AE • 978-1-84425-946-5  
\$32.95 US/\$35.99 CAN

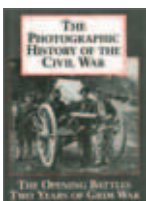

### The Photographic History of the Civil War Volume 1

The Opening Battles Two Years of Grim War  
Hardcover • 8 x 11 in  
732 pages  
164639 BK • 978-1-55521-174-5  
\$19.99 US/\$21.99 CAN

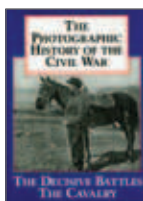

### The Photographic History of the Civil War Volume 2

The Decisive Battles The Cavalry  
Hardcover • 8 x 11 in  
688 pages  
162446 BK • 978-1-55521-199-8  
\$19.99 US/\$21.99 CAN

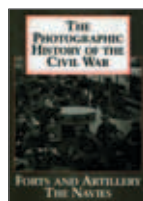

### The Photographic History of the Civil War Volume 3

Forts and Artillery The Navies  
Hardcover • 8 x 11 in  
640 pages  
163644 BK • 978-1-55521-203-2  
\$19.99 US/\$21.99 CAN

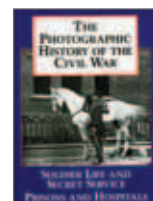

### The Photographic History of the Civil War Volume 4

Soldier Life and Secret Service Prisons and Hospitals  
Hardcover • 8 x 11 in  
732 pages  
162799 BK • 978-1-55521-201-8  
\$19.99 US/\$21.99 CAN

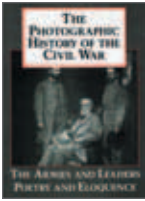

**The Photographic History of the Civil War Volume 5**  
The Armies and Leaders Poetry and Eloquence  
Hardcover • 8 x 11 in  
712 pages  
164638 BK • 978-1-55521-202-5  
\$19.99 US/\$21.99 CAN



**Piercing the Fog of War**  
Recognizing Change on the Battlefield: Lessons from Military History, 216 BC Through Today  
Brian L. Steed  
Hardcover • 6 x 9 in  
320 pages • 23 color photos  
145809 AP • 978-0-7603-3523-9  
\$30.00 US/\$32.95 CAN/£16.99 UK



**Pirates and Privateers**  
Tom Bowling  
Hardcover • 5 x 7.25 in  
160 pages  
159995 BK • 978-1-84243-231-0  
\$8.99 US



**Plough & Scatter**  
The Diary-Journal of a First World War Gunner  
Alan Wakefield and J. Ivor Hanson  
Paperback • 6 x 9 in  
352 pages • 16 color photos  
200122 AE • 978-0-85733-136-6  
\$14.95 US/\$16.99 CAN



**Rank and Rate**  
Volume II: Insignia of Royal Naval Ratings, WRNS, Royal Marines, QARNNS and Auxiliaries  
E. C. Coleman  
Hardcover • 8.25 x 12 in  
96 pages • 750 color photos  
200111 AE • 978-1-84797-308-5  
\$34.95 US/\$38.99 CAN

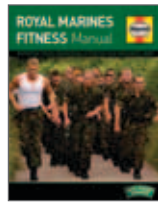

**Royal Marines Fitness Manual**  
Improve Your Personal Fitness the Marines Way  
Various  
Hardcover • 8.25 x 10.65 in  
160 pages • 200 color photos  
148984 AE • 978-1-84425-561-0  
\$35.95 US/\$39.95 CAN



**Samurai Battles**  
Japan's Warrior Lords in 700 Years of Conflict  
Michael Sharpe  
Hardcover • 9.34 x 12.375 in  
192 pages  
166165 BK • 978-0-78582-379-7  
\$19.99 US/\$21.99 CAN



**Sniping**  
An Illustrated History  
Pat Farey and Mark Spicer  
Hardcover • 9 x 12 in  
256 pages • 200 color & 173 b/w photos  
147288 AP • 978-0-7603-3717-2  
\$30.00 US/\$37.50 CAN

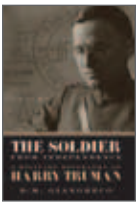

**The Soldier from Independence**  
A Military Biography of Harry Truman  
D. M. Giangreco and Alonzo L. Hamby  
Hardcover • 5.5 x 8.5 in  
304 pages • 33 b/w photos  
145475 AP • 978-0-7603-3209-2  
\$28.00 US/\$34.99 CAN/£16.99 UK



**Special Ops, 1939-1945**  
A Manual of Covert Warfare and Training  
Stephen Bull  
Hardcover • 4.92 x 7.52 in  
160 pages • 40 color photos  
149562 AP • 978-0-7603-3751-6  
\$17.00 US/\$21.50 CAN



**Spycamera: The Minox Story**  
Second Edition  
Morris Moses and John Wade  
Hardcover • 6 x 8.5 in  
224 pages • color photos  
141775 AE • 978-1-87470-728-8  
\$35.95 US/\$39.95 CAN



**A Spy's Journey**  
A CIA Memoir  
Floyd Paseman  
Paperback • 6 x 9 in  
320 pages • color photos  
147307 AP • 978-0-7603-3735-6  
\$17.99 US/\$22.50 CAN/£12.99 UK



**Spearhead**  
**The Stonewall Brigade in the Civil War**  
Patrick Hook and Steve Smith  
Paperback • 7.25 x 9.75 in  
128 pages • 25 color & 110 b/w photos  
144489 AP • 978-0-7603-3050-0  
\$21.99 US/\$23.95 CAN/£12.99 UK



**The Timechart History of The Civil War**  
David Gibbons  
Hardcover • 10 x 12.5 in  
144 pages  
195450 BK • 978-0-78582-876-1  
\$17.99 US/\$19.99 CAN



**Victory at Risk**  
Restoring America's Military Power: A New War Plan for the Pentagon  
Major General Michael W. Davidson, U.S. Army (Ret.)  
Hardcover • 5.5 x 8.5 in  
256 pages • color photos  
145844 AP • 978-0-7603-3557-4  
\$25.00 US/\$27.50 CAN/£15.99 UK



**War Stories of the Infantry**  
Americans in Combat, 1918 to Today  
Michael Green and James D. Brown  
Hardcover • 6 x 9 in  
320 pages • 37 b/w photos  
145861 AP • 978-0-7603-3569-7  
\$28.00 US/\$29.95 CAN/£17.99 UK



### War Stories of the Tankers

American Armored Combat, 1918 to Today

Michael Green

Hardcover • 6 x 9 in

320 pages • 42 b/w photos

145410 AP • 978-0-7603-3297-9

\$24.95 US/\$27.95 CAN/£16.99 UK



### Wars That Changed The World

Charles Messenger

Hardcover • 7.25 x 10.5 in

208 pages

160095 BK • 978-1-84724-161-0

\$12.99 US/\$14.99 CAN



### The Way of the Samurai

Inazo Nitobe

Hardcover • 5.25 x 7.25 in

128 pages

180765 BK • 978-1-84837-722-6

\$8.99 US/\$9.99 CAN



### What We Need

Extravagance and Shortages in America's Military

Barrett Tillman

Hardcover • 5.5 x 8.5 in

256 pages • color photos

144281 AP • 978-0-7603-2869-9

\$27.95 US/\$34.95 CAN/£18.99 UK



See Page 28

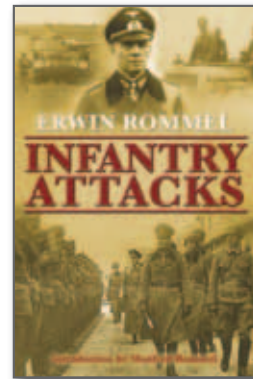

"There are few books that influenced my understanding of combat as much as German Field Marshal Erwin Rommel's memoir of being a young leader in World War I. Generations of soldiers read Rommel's book and employed his sober and successful tactics."

— *The Week*

See Page 27



### The Civil War Day By Day

- The Civil War's battles, politics, and people—all at a glance.
- Principal commanders and political figures, key technology, transportation, and weaponry, all receive due treatment.
- Goes beyond the major engagements of the war to cover lesser episodes and partisan activities, providing a reference that is at once fingertip-quick and comprehensive.



### Infantry Attacks

- Rommel is the most famous German general of World War II.
- Rommel's book is on the reading list of virtually every military college around the world.
- This is the only memoir of Rommel, who died during World War II.
- Shows how Rommel learned from his experiences in World War I as an infantry combat leader.

# BATTLE GEAR



## Europa Militaria American Web Equipment 1910-1967

Martin J. Brayley

This book gives a detailed, illustrated overview of the webbing straps, holsters, carriers and haversacks used by American combat troops from before World War One to the Vietnam War. This book is invaluable for all students of American uniform and equipment, modelers, re-enactors and collectors.

Paperback • 7.5 x 10.25 in

64 pages • 100 color photos

144851 AE • 978-1-86126-832-7

\$19.95 US/\$24.99 CAN

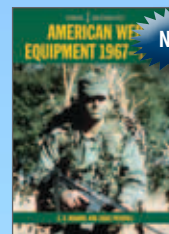

## Europa Militaria American Web Equipment 1967-1991

C. A. Monroe and Craig Pickrall

From the beginning of the twentieth century, United States military individual load-carrying equipments were fabricated mainly of cotton duck and cotton webbing. Throughout the First and Second World Wars, as well as the Korean War, cotton-based load-carrying equipments served the infantryman with little change in their design and construction.

Paperback • 7.5 x 10.2 in

64 pages • 160 color photos

200562 AE • 978-1-84797-315-3

\$19.95 US

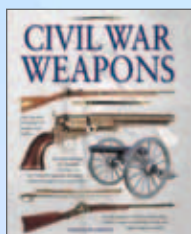

## Civil War Weapons

Graham Smith

This book includes chapters on pistols and revolvers; carbines; longarms and rifles; swords and edged weapons; and artillery. Over 160 weapons are featured with a history and specifications for each.

Hardcover • 8.25 x 11 in

256 pages • color photos

180833 BK • 978-0-78582-854-9

\$14.99 US/\$16.99 CAN



## The Complete Illustrated Manual of Handgun Skills

Robert Campbell

This heavily illustrated guide introduces you to the world of handguns, from choosing your first handgun to understanding the basics of firearms safety, marksmanship, competitive shooting, hunting and personal protection.

Paperback • 6 x 9 in

256 pages • 229 color photos

193348 AP • 978-0-7603-4105-6

\$27.99 US/\$29.99 CAN/£18.99 UK

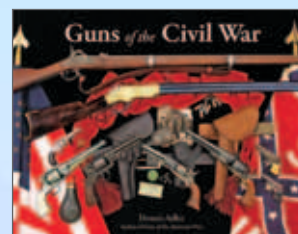

## Guns of the Civil War

Dennis Adler

Celebrate the 150th anniversary of the Civil War with this detailed history of Colt, Henry, Manhattan, Remington, and other rivals and contemporaries. Photography of handguns, rifles, and muskets capture the detail of each piece.

Hardcover • 11.125 x 8.625 in

352 pages • 300 color & 150 b/w photos

149849 AP • 978-0-7603-3971-8

\$40.00 US/\$44.00 CAN/£30.00 UK



## The Illustrated History of Firearms

In Association with the National Firearms Museum

Jim Supica, Doug Wicklund and Philip Schrier

This significant tome, with over 1500 photographs, covers the subject of portable firearms from muzzle-loaders to submachine-guns. Compiled by experts with hands-on knowledge and skill, The Illustrated History of Firearms provides a visual reference book to grace any aficionado's library.

Hardcover • 11.25 x 9 in

304 pages • color photos

180480 BK • 978-0-78582-738-2

\$29.99 US/\$32.99 CAN

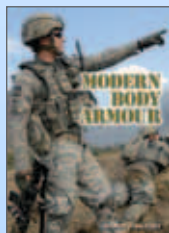

## Modern Body Armour

Martin J. Brayley

This book traces the development of ballistic protection from multi-layer silk and metal plates used during World War One, to the armour currently used in Iraq and illustrates all of the armour in use from 1914 to the present day.

Hardcover • 8.5 x 11.65 in

160 pages • 400 color photos

196321 AE • 978-1-84797-248-4

\$34.95 US/\$38.99 CAN



## Sub-Machine Gun

The Development of Sub-Machine Guns and their Ammunition from World War 1 to the Present Day

Maxim Popenker and Anthony G. Williams

Weapons experts Maxim Popenker and Anthony Williams present a study of the development of the sub-machine gun and its ammunition, before undertaking a country-by-country survey of the weapons designed, built and used across the world.

Hardcover • 9.5 x 10 in

320 pages • 550 color and b/w photos

200112 AE • 978-1-84797-293-4

\$49.95 US/\$55.00 CAN

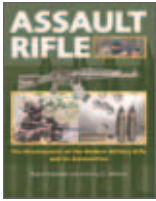

### Assault Rifle

Maxim Popenker  
Hardcover • 8 x 10 in  
224 pages • color photos  
139240 AE • 978-1-86126-700-9  
\$34.95 US/\$38.99 CAN



### Europa Militaria British Post-War Jungle Webbing

Simon Howlett  
Paperback • 7.5 x 10.25 in  
64 pages • 160 color photos  
150162 AE • 978-1-84797-086-2  
\$19.95 US/\$24.99 CAN/£24.99 UK



### Camouflage Uniforms

International Combat Dress 1940-2010  
Martin J. Brayley  
Hardcover • 8.25 x 12 in  
96 pages • 400 color photos  
181011 AE • 978-1-84797-137-1  
\$34.95 US/\$56.00 CAN



### The Great Warbow

From Hastings to the Mary Rose  
Matthew Strickland and Robert Hardy  
Hardcover • 9 x 11 in  
560 pages • 200 color & 150 b/w photos  
199739 AE • 978-0-85733-090-1  
\$57.95 US/\$62.50 CAN



### The Guns that Won the West

Firearms on the American Frontier, 1848-1898  
John Walter  
Paperback • 6.25 x 9.25 in  
304 pages • color photos  
144084 AE • 978-1-85367-692-5  
\$19.95 US/\$21.95 CAN



### The Historical Atlas of Weaponry

Hardcover • 10 x 13 in  
400 pages  
179901 BK • 978-0-78582-595-1  
\$29.99 US/\$32.99 CAN



### A History of Handguns

Frederick Wilkinson  
Hardcover • 6.7 x 9.5 in  
192 pages • 240 color photos  
193994 AE • 978-1-84797-225-5  
\$34.95 US/\$38.99 CAN

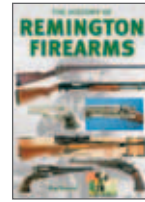

### The History of Remington Firearms

The History of One of the World's Most Famous  
Gun Makers  
Roy Marcot  
Hardcover • 8.5 x 12 in  
128 pages • color photos  
180834 BK • 978-0-78582-855-6  
\$12.99 US/\$14.99 CAN

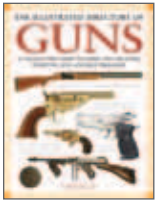

### The Illustrated Directory of Guns

A Collector's Guide to Over 1500 Military,  
Sporting and Antique Firearms  
David Miller  
Hardcover • 8.5 x 11 in  
512 pages • color photos  
180651 BK • 978-0-78582-801-3  
\$24.99 US/\$27.99 CAN



### Longbow

A Social and Military History  
Robert Hardy  
Paperback • 6.25 x 9.4375 in  
224 pages • 80 b/w photos  
146267 AE • 978-1-85260-620-6  
\$27.95 US/\$29.95 CAN



### The M 16

Jean Huon  
Hardcover • 8.5 x 12 in  
160 pages • 300 color & b/w photos  
138910 AE • 978-1-93203-325-0  
\$37.95 US



### The M-1 Carbine

Classic American Small Arms at War  
Hardcover • 11.375 x 8.875 in  
96 pages • 100 photos  
144904 AE • 978-0-97483-892-2  
\$39.95 US



### M4 Carbine

Eric M.  
Paperback • 9.5 x 7.8 in  
82 pages • color photos  
199907 AE • 978-2-35252-098-8  
\$19.95 US/\$21.95 CAN



### Machine Gun

The Development of the Machine Gun from the  
Nineteenth Century to the Present Day  
Maxim Popenker and Anthony G. Williams  
Hardcover • 7.4375 x 9.6875 in  
352 pages • 600 color photos  
147814 AE • 978-1-84797-030-5  
\$59.95 US



### Medieval Military Costume

Europa Militaria Special No. 8  
Gerry Embleton  
Paperback • 7.5 x 10.25 in  
96 pages • 160 color photos  
131209 AE • 978-1-86126-371-1  
\$24.95 US



### Europa Militaria Modern British Webbing Equipment

Simon Howlett  
Paperback • 7.5 x 10.5 in  
64 pages • 160 color photos  
181014 AE • 978-1-84797-140-1  
\$19.95 US/\$31.99 CAN



### The Roman Legions Recreated In Color Photographs

D. Peterson  
Paperback • 7.5 x 10.25 in  
96 pages • 120 color photos  
128269 AE • 978-1-86126-264-6  
\$24.95 US

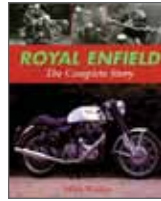

**Royal Enfield**  
The Complete Story  
Mick Walker  
Hardcover • 7.75 x 9.875 in  
192 pages • color photos  
136597 AE • 978-1-86126-563-0  
\$34.95 US



**The Samurai**  
Mitsuo Kure  
Paperback • 7.5 x 10.25 in  
96 pages • color photos  
130660 AE • 978-1-86126-335-3  
\$24.95 US



**Samurai Swords**  
Clive Sinclair  
Hardcover • 9 x 12 in  
192 pages  
157212 BK • 978-0-78582-563-0  
\$19.99 US/\$21.99 CAN

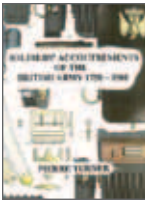

**Soldiers' Accoutrements of the British Army 1750-1900**  
Pierre Turner  
Hardcover • 8.25 x 11.6875 in  
96 pages • 84 color plates  
145283 AE • 978-1-86126-883-9  
\$34.95 US/\$38.99 CAN



**Soviet Military and Paramilitary Services: Female Uniforms 1941-1991**  
(officer and enlisted personnel)  
Adrian Streater  
Paperback • 8 x 10 in  
128 pages • 250 color & b/w photos  
192347 AE • 978-1-84584-067-9  
\$29.95 US/\$32.99 CAN



**Soviet Uniforms & Militaria 1917 - 1991**  
in Colour Photographs  
Laszlo Bekesi and Gyorgy Torok  
Paperback • 8.5 x 12 in  
144 pages • 300 color photos  
196281 AE • 978-1-84797-260-6  
\$34.95 US/\$38.99 CAN



**Tin Hats to Composite Helmets**  
A Collector's Guide  
Martin J. Brayley  
Hardcover • 8.25 x 11.6875 in  
160 pages • 700 color photos  
147813 AE • 978-1-84797-024-4  
\$34.95 US



**Tommy's War**  
British Military Memorabilia, 1914-1918  
Peter Doyle  
Hardcover • 8.25 x 9.75 in  
208 pages • 564 color photos  
146618 AE • 978-1-86126-996-6  
\$34.95 US/\$43.99 CAN

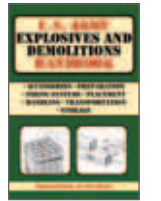

**U.S. Army Explosives and Demolitions Handbook**  
Department Of The Army  
Paperback • 5.5 x 8.75 in  
192 pages • 200 b/w photos  
192804 AE • 978-1-61608-008-2  
\$12.95 US/\$16.50 CAN

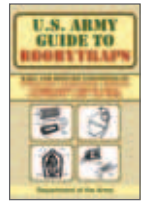

**U.S. Army Guide to Booby Traps**  
Department Of The Army  
Paperback • 5 x 7 in  
136 pages • 100 b/w photos  
192791 AE • 978-1-60239-940-2  
\$12.95 US/\$16.50 CAN



**U.S. Army Hand-to-Hand Combat**  
Department Of The Army  
Paperback • 5 x 7 in  
208 pages • 225 b/w photos  
192793 AE • 978-1-60239-782-8  
\$12.95 US/\$16.50 CAN



**U.S. Army Survival, Evasion, and Recovery**  
United States Department of Defense  
Paperback • 5.1 x 7.5 in  
112 pages • 105 b/w photos  
192796 AE • 978-1-60239-335-6  
\$9.95 US/\$12.50 CAN



**U.S. Army Weapons Systems 2010-2011**  
Department Of The Army  
Paperback • 8.5 x 11 in  
320 pages • 600 color photos  
192798 AE • 978-1-60239-725-5  
\$19.95 US/\$24.99 CAN



**The Ultimate Guide to U.S. Army Combat Skills, Tactics, and Techniques**  
Department Of The Army  
Paperback • 8.5 x 11 in  
960 pages • 700 b/w photos  
192805 AE • 978-1-61608-010-5  
\$24.95 US/\$31.99 CAN



**The Vikings**  
Recreated in Colour Photographs  
Britta Nurmman, Carl Schulze and  
Torsten Vernilsdonk  
Paperback • 7.5 x 10.25 in  
96 pages • color photos  
128659 AE • 978-1-86126-289-9  
\$24.95 US

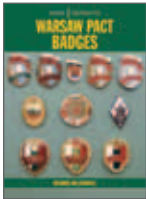

**Europa Militaria  
Warsaw Pact Badges**

Richard Hollingdale  
Paperback • 7.5 x 10.25 in  
64 pages • 120 color photos  
200108 AE • 978-1-84797-281-1  
\$19.95 US/\$21.99 CAN

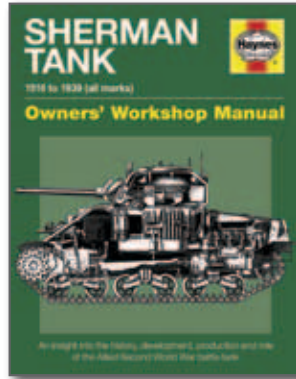

See Page 37

**Sherman Tank  
Owners' Workshop Manual**

- The M4 Sherman tank is the most important American tank of World War II.
- Hundreds of Shermans are in the collections of museums around the country, many of them in operational condition. There are also scores of operational Shermans in private collections.
- The Haynes "historical" owners manuals have proven very popular.

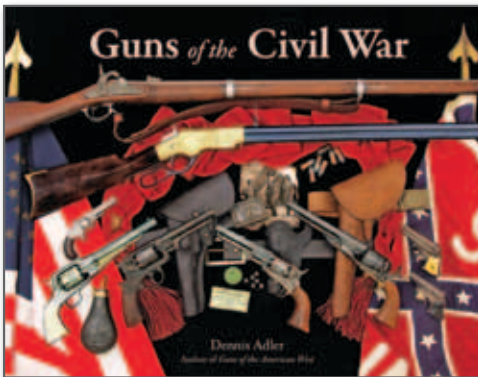

"There is no shortage of existing books on Civil War firearms, but Adler's is a beautiful addition. It should be welcome in all Civil War and firearm history collections as the sesquicentennial years of the war increase interest."  
— *Library Journal Xpress Reviews*

See Page 32



See Page 32



**Guns of the Civil War**

- There are 62 official Civil War Clubs across the United States, with more than 200,000 active members. Re-enactments dominate their activities. These events involve the entire family, including children.
- Coincides with a reissue of Ken Burns' Civil War PBS program, as well as Civil War—themed movies planned from Hollywood during the Civil War sesquicentennial years (2011-2015).



**The Complete Illustrated Manual of  
Handgun Skills**

- Interest in personal defense and availability of concealed carry permits at an all-time high.
- Springfield Armory alone sold 150,000 handguns last year, with each new handgun owner a potential customer for the book.
- Author Robert Campbell is a frequent contributor to *American Gunsmith*, *Gun Week*, *Gun Digest*, and several police and SWAT trade publications. His other books have received numerous positive reviews in publications such as these.

# WW2

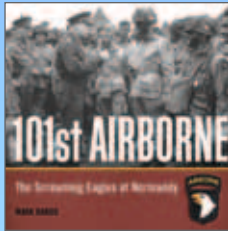

## 101st Airborne

The Screaming Eagles at Normandy

Mark Bando

This minute-by-minute, day-by-day account of the elite 101st Airborne's daring parachute landing behind enemy lines at Normandy is accompanied by firsthand accounts from Airborne veterans and previously unknown color photos of the "Screaming Eagles" prior to the invasion.

Paperback • 10 x 10 in

156 pages • 40 color & 302 b/w photos

149855 AP • 978-0-7603-3980-0

\$29.99 US/\$32.99 CAN/£20.00 UK



## The Battle of the Bulge

The Photographic History of an American Triumph

John R. Bruning

A photographic history of the triumph of American arms against the vaunted Nazi war machine's desperate "all in" attack in one of history's greatest battles.

Paperback • 9.625 x 11 in

300 pages • 29 color & 410 b/w photos

193465 AP • 978-0-7603-4126-1

\$29.99 US/\$32.99 CAN/£20.00 UK

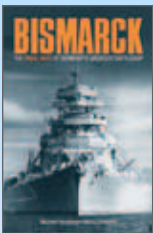

## Bismarck

The Final Days of Germany's Greatest Battleship

Niklas Zetterling

This book details the events of the sinking of the German battleship Bismarck—a masterpiece of engineering, well-armed with a main artillery of eight 15-inch guns—which was one of the most dramatic events of World War II.

Hardcover • 6 x 9 in

320 pages • b/w photos

193774 AE • 978-1-93514-904-0

\$32.95 US/\$35.99 CAN



## Blood Red Snow

The Memoirs of a German Soldier on the Eastern Front

Gunther K. Koschorrek

For German soldiers fighting under Hitler, diaries were strictly forbidden. Gunther Koschorrek wrote notes scraps of paper and sewed the pages into the lining of his winter coat. This remarkable document is a day-to-day account of the German soldier's experience.

Paperback • 6 x 9 in

288 pages • color photos

139858 AP • 978-0-7603-2198-0

\$18.99 US/\$20.95 CAN/£12.99 UK



## Fighting Patton

George S. Patton Jr. Through the Eyes of His Enemies

Harry Yeide

*Fighting Patton* is the first book to examine the legendary general through the eyes of his enemies, the opposing German commanders.

Hardcover • 6.25 x 9.25 in

528 pages • 90 b/w photos

193453 AP • 978-0-7603-4128-5

\$30.00 US/\$33.00 CAN/£20.00 UK



## Fortress Rabaul

The Battle for the Southwest Pacific, January 1942-April 1943

Bruce Gamble

Winner of the "Gold Medal" (Military Writers Society of America) and "Editor's Choice Award" (Stone & Stone Second World War Books), *Fortress Rabaul* details a critical and, until now, little understood chapter in the history of World War II.

Hardcover • 6 x 9 in

416 pages • 37 b/w photos

140301 AP • 978-0-7603-2350-2

\$28.00 US/\$30.00 CAN/£20.00 UK



## German Automatic Weapons of World War II

Robert Bruce

This book provides detailed descriptions and color photography of seven classic automatic weapons of the World War II German Wehrmacht.

Paperback • 8.25 x 11.6 in

128 pages • 200 color & 36 b/w photos

193724 AE • 978-1-84797-214-9

\$29.95 US/\$32.99 CAN

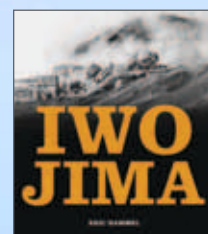

## Iwo Jima

Portrait of a Battle: United States Marines at War in the Pacific

Eric Hammel

The fighting on Iwo Jima—thirty-four of the bloodiest days of the Pacific War—comes to harrowing life in this volume, including detailed maps as well as profiles of each Medal of Honor winner from the battle.

Paperback • 9.625 x 11 in

256 pages • 8 color & 528 b/w photos

147305 AP • 978-0-7603-3733-2

\$24.99 US/\$31.99 CAN/£16.00 UK



### Last Man Standing

The 1st Marine Regiment on Peleliu,  
September 15-21, 1944

Dick Camp

This book is a harrowing account of one of the bloodiest battles in Marine Corps history, drawn from extensive personal interviews and never-before-published sources.

Paperback • 6 x 9 in

320 pages • 105 b/w photos

193474 AP • 978-0-7603-4127-8

\$18.99 US/\$20.99 CAN/£14.99 UK



### Lost Victories

Erich Manstein

Field Marshal Erich von Manstein described his book as a personal narrative of a soldier, discussing only those matters that had direct bearing on events in the military field.

Paperback • 5.375 x 8.5 in

592 pages • 10 color & 32 b/w photos

138673 AP • 978-0-7603-2054-9

\$22.99 US/\$28.99 CAN/£14.99 UK



### Enthusiasts' Manual Military Jeep

1940 Onwards (Ford, Willys and Hotchkiss)

Pat Ware

This book provides a brief history of this iconic vehicle, and a fascinating behind-the-scenes insight into what is involved in restoring, operating and maintaining a Jeep today, 70 years after the prototype first appeared.

Hardcover • 8.25 x 10.5 in

160 pages • 200 color & 60 b/w photos

192437 AE • 978-1-84425-933-5

\$34.95 US/\$38.99 CAN

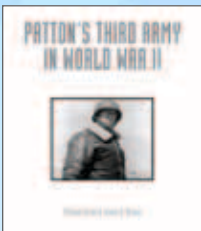

### Patton's Third Army in World War II

An Illustrated History

Michael Green and James D. Brown

This book covers Patton's command of Third Army with a focus on the armor. Archival photos along with frequent quotes complete the portrait of the Third Army as they fight their way across the Third Reich.

Hardcover • 10.75 x 12.25 in

300 pages • 48 color & 416 b/w photos

147257 AP • 978-0-7603-3691-5

\$50.00 US/\$55.00 CAN/£35.00 UK



### Owners' Workshop Manual Sherman Tank

1916-1939 (all marks)

An insight into the history, development, production and role of the Allied Second World War battle tank

Pat Ware

Whether you are an armchair General Patton or a serious collector, tips on buying a tank, special tools, handling heavy components, and recommended fluids and lubricants from this book will prove invaluable.

Hardcover • 8.528 x 10.879 in

160 pages • 250 color & 50 b/w photos

194820 AP • 978-0-7603-4294-7

\$28.00 US/\$30.00 CAN

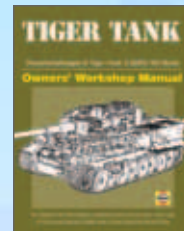

### Owners' Workshop Manual Tiger Tank

Panzerkampfwagen VI Tiger 1 Ausf.E (SdKfz 181) Model

David Fletcher

With personal recollections of those who commanded a Tiger in war, *Tiger Tank* provides insight into acquiring, owning and operating what was probably the most feared battle tank of the Second World War.

Hardcover • 8.5 x 10.875 in

160 pages • 200 color & 50 b/w photos

193315 AP • 978-0-7603-4078-3

\$28.00 US/\$30.00 CAN



### World War II Day By Day

Antony Shaw

This book is a history of the conflict from the beginning of the Polish campaign in 1939 to the surrender of Japan in 1945. The dated entries recapture the immediacy of the war and analyze the major battles and campaigns.

Hardcover • 8.5 x 11 in

192 pages • color photos

180358 BK • 978-0-7858-2663-7

\$12.99 US/\$14.99 CAN

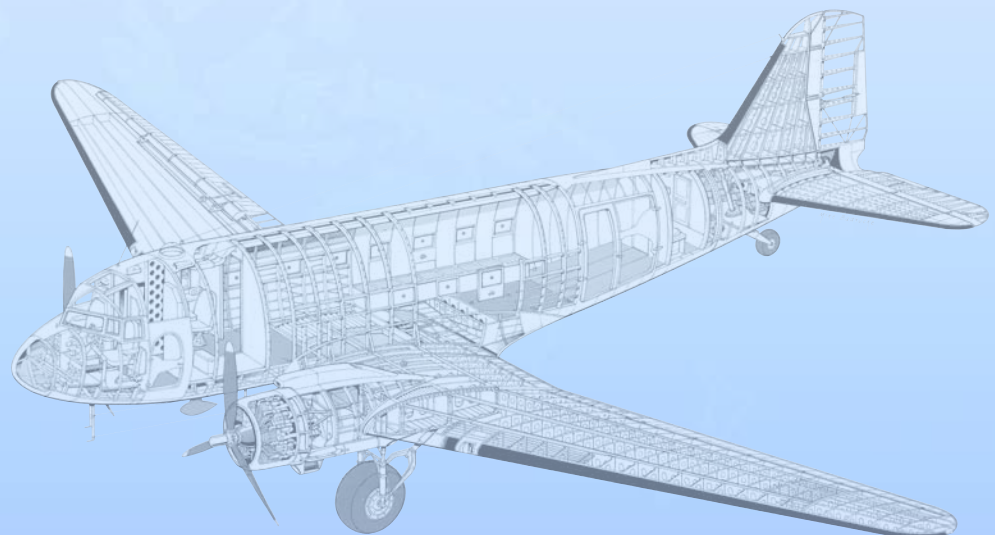



### Spearhead 4th Armored Division in World War II

George Forty  
Paperback • 7.25 x 9.75 in  
128 pages • 25 color & 78 b/w photos  
144579 AP • 978-0-7603-3160-6  
\$21.99 US/\$23.95 CAN/£12.99 UK



### All American, All the Way

A Combat History of the 82nd Airborne Division  
in World War II: From Market Garden to Berlin

Phil Nordyke  
Paperback • 6 x 9 in  
432 pages • 87 b/w photos  
149649 AP • 978-0-7603-3823-0  
\$22.99 US/\$28.99 CAN/£14.99 UK



### All American, All the Way

A Combat History of the 82nd Airborne Division  
in World War II: From Sicily to Normandy

Phil Nordyke  
Paperback • 6 x 9 in  
464 pages • 88 b/w photos  
147309 AP • 978-0-7603-3737-0  
\$22.99 US/\$28.99 CAN/£14.99 UK

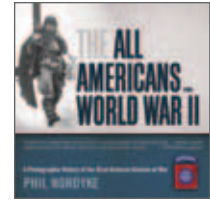

### The All Americans in World War II

A Photographic History of the 82nd Airborne  
Division at War  
Phil Nordyke  
Paperback • 9 x 9 in  
192 pages • 448 b/w photos  
149775 AP • 978-0-7603-3914-5  
\$22.99 US/\$24.99 CAN/£14.99 UK

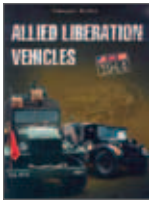

### Allied Liberation Vehicles

United States, Great Britain, Canada  
Francois Bertin  
Paperback • 7 x 10 in  
128 pages • color photos  
146172 AE • 978-1-93203-376-2  
\$24.95 US



### American Battleships

A Pictorial History of BB-1 to BB-71  
Max Newhart  
Paperback • 8.5 x 11 in  
106 pages • 138 b/w photos  
122862 AE • 978-1-57510-004-3  
\$9.95 US/\$10.95 CAN



### American Paratrooper Helmets

Mediterranean & European Theater of Operations  
Michel De Trez  
Hardcover • 9.3 x 12.4 in  
272 pages • 300 color photos  
199872 AE • 978-2-35250-141-1  
\$49.95 US/\$55.00 CAN



### America's Fighting Admirals

Winning the War at Sea in World War II  
William Tuohy  
Hardcover • 6.25 x 9.25 in  
400 pages • 71 b/w photos  
144371 AP • 978-0-7603-2985-6  
\$25.95 US/\$31.95 CAN/£16.99 UK



### The Attack on Pearl Harbor

Strategy, Combat, Myths, Deceptions  
Alan Zimm  
Hardcover • 6 x 9 in  
336 pages • b/w photos  
199874 AE • 978-1-61200-010-7  
\$32.95 US/\$35.99 CAN



### Blood, Steel, & Myth

The II. SS-Panzer-Korps and the Road to  
Prochorowka, July 1943  
George Nipe Jr.  
Hardcover • 8.5 x 11 in  
448 pages • 220 b/w photos  
199880 AE • 978-0-97483-894-6  
\$65.00 US/\$72.00 CAN



### The Bloody Triangle

The Defeat of Soviet Armor in the Ukraine,  
June 1941  
Victor J. Kamenir  
Hardcover • 6 x 9 in  
336 pages • 27 b/w photos  
145723 AP • 978-0-76033-434-8  
\$30.00 US/\$32.95 CAN/£17.99 UK



### A Blue Sea of Blood

Deciphering the Mysterious Fate of  
the USS Edsall  
Donald M. Kehn, Jr.  
Hardcover • 6 x 9 in  
304 pages • 54 b/w photos  
145530 AP • 978-0-7603-3353-2  
\$26.00 US/\$28.95 CAN/£16.99 UK



### British Web Equipment of the Two World Wars

Martin J. Brayley  
Paperback • 7.5 x 10.25 in  
64 pages • color photos  
140212 AE • 978-1-86126-743-6  
\$19.95 US/\$21.99 CAN



### Buying and Selling Wartime Collectables

An Enthusiast's Guide to Militaria  
Arthur Ward and Richard Ingram  
Hardcover • 8.25 x 11.6875 in  
128 pages • 250 color photographs  
145920 AE • 978-1-86126-892-1  
\$34.95 US



### Churchill's Secret Weapons

The Story of Hobart's Funnies  
Hardcover • 6.375 x 9.50 in  
224 pages • color photos  
144917 AE • 978-1-84415-344-2  
\$39.99 US



### D-Day and the Battle of Normandy

The Photographic History  
Simon Trew  
Hardcover • 10 x 10 in  
320 pages • 500 b/w photos  
200171 AE • 978-1-84425-868-0  
\$49.95 US/\$55.00 CAN



**D-Day Normandy**  
Weapons, Uniforms, Military Equipment  
Francois Bertin  
Paperback • 7 x 10 in  
128 pages • color photos  
146173 AE • 978-1-93203-377-9  
\$24.95 US



**D-Day Paratroopers  
Volume 1**  
US Airborne Division  
Christophe Deschodt  
Paperback • 9 x 11.6 in  
128 pages • color photos  
199885 AE • 978-2-35250-170-1  
\$44.95 US/\$49.99 CAN



**Deutsche Soldaten**  
Uniforms, Equipment & Personal Items of the  
German Soldier 1939-45  
Agustin Saiz  
Hardcover • 8 x 12 in  
312 pages • color photos  
180964 AE • 978-1-93203-396-0  
\$55.00 US/\$69.00 CAN

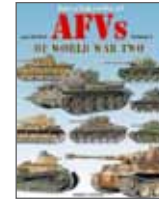

**Encyclopedia of AFVs of WWII  
Volume 1**  
Tanks  
Jean Rrestayn  
Hardcover • 9.25 x 12.5 in  
128 pages • color photos  
140399 AE • 978-2-91523-947-8  
\$44.95 US



**Encyclopedia of Elite Forces  
in the Second World War**  
Paratroops, Commandos, Rangers, Waffen SS  
Michael E. Haskew  
Hardcover • 7.5 x 9.5 in  
192 pages • 100 color photos  
146243 AE • 978-1-90570-427-9  
\$34.95 US/\$38.95 CAN



**The Enemy I Knew**  
German Jews in the Allied Military in  
World War II  
Steven Karras and Michael Berenbaum  
Hardcover • 6 x 9 in  
320 pages • 27 b/w photos  
147132 AP • 978-0-7603-3586-4  
\$28.00 US/\$34.99 CAN/£16.99 UK



**Erich Von Manstein**  
Hitler's Master Strategist  
Benoit Lemay  
Paperback • 6 x 9 in  
528 pages • b/w photos  
199886 AE • 978-1-61200-059-6  
\$16.95 US/\$18.99 CAN



**Feldbluse**  
The German Army Field Tunic 1933-45  
Jean-Phillippe Borg  
Hardcover • 9 x 12 in  
144 pages • color photos  
180976 AE • 978-2-35250-010-0  
\$44.95 US/\$75.00 CAN



**Fighting Men of World War II  
Allied Forces**  
Uniforms, Equipment & Weapons  
David Miller  
Hardcover • 9 x 11.75 in  
384 pages • color photos  
180670 BK • 978-0-78582-814-3  
\$19.99 US/\$21.99 CAN



**Fighting Men of World War II  
Axis Forces**  
Uniforms, Equipment & Weapons  
David Miller  
Hardcover • 9 x 11.75 in  
384 pages • color photos  
180671 BK • 978-0-78582-815-0  
\$19.99 US/\$21.99 CAN



**Four Stars of Valor**  
The Combat History of the 505th Parachute  
Infantry Regiment in World War II  
Phil Nordyke  
Paperback • 6 x 9 in  
480 pages • 57 color photos  
149771 AP • 978-0-7603-3905-3  
\$19.99 US/\$21.99 CAN/£16.99 UK



**The Fujita Plan**  
Japanese Attacks on the United States and  
Australia during the Second World War  
Mark Felton  
Hardcover • 6.5 x 9.5 in  
224 pages • 16 b/w photos  
146181 AE • 978-1-84415-480-7  
\$39.95 US



**G.I. Collector's Guide**  
Army Service Forces Catalog: US Army European  
Theater of Operations  
Henry-Paul Enjames  
Hardcover • 9.5 x 12.5 in  
282 pages • color photos  
180947 AE • 978-2-35250-080-3  
\$49.95 US/\$82.00 CAN



**G.I. Collector's Guide  
Volume 2**  
Army Service Forces Catalog: US Army  
European Theater of Operations  
Henry-Paul Enjames  
Hardcover • 9.5 x 12.5 in  
276 pages • color photos  
180948 AE • 978-2-35250-079-7  
\$49.95 US/\$82.00 CAN



**German Anti-Tank Weapons**  
Panzerbuchse, Panzerfaust AND Panzerschre  
Guis De Vries  
Hardcover • 9 x 9 in  
150 pages • 220 photos  
193781 AE • 978-9-08055-838-0  
\$39.95 US/\$43.99 CAN



**German Army Uniforms of  
World War II**  
Wade Krawczyk  
Hardcover • 8 x 12 in  
128 pages • 230 color photos  
135374 AE • 978-1-86126-268-4  
\$49.95 US

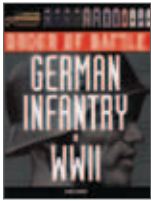

### Order of Battle German Infantry in World War II

Chris Bishop  
Paperback • 7.5 x 9.5 in  
192 pages • 25 color & 225 b/w photos  
144589 AP • 978-0-7603-3187-3  
\$19.95 US/\$21.95 CAN



### German Military Equipment WW2

R.M. Clarke  
Paperback • 8 x 10.75 in  
384 pages • color photos  
131505 AE • 978-1-85520-549-9  
\$39.95 US/\$43.95 CAN



### The German Army Mountain Soldier of WWII

Wade Krawczyk and Bart Jansen  
Hardcover • 8.25 x 12 in  
128 pages • 260 color & 40 b/w photos  
150163 AE • 978-1-84797-097-8  
\$44.95 US/\$49.99 CAN/£56.00 UK



### German Panzer Markings

From Wartime Photographs  
Ian Baxter  
Hardcover • 8.25 x 11.6875 in  
136 pages • 20 color & 220 b/w photos  
145286 AE • 978-1-86126-897-6  
\$34.95 US

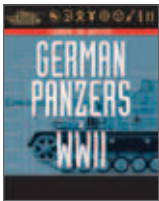

### Order of Battle German Panzers in World War II

Chris Bishop  
Paperback • 7.5 x 9.5 in  
192 pages • 25 color & 225 b/w photos  
144491 AP • 978-0-7603-3116-3  
\$19.95 US/\$23.95 CAN



### German Soldiers of World War Two

Jean De La Garde  
Hardcover • 9.3125 x 12.5 in  
160 pages • color photos  
140093 AE • 978-2-91523-935-5  
\$44.95 US



### Enthusiast Color German Tanks of World War II in Color

Michael Green  
Paperback • 8.25 x 9 in  
96 pages • color photos  
129832 AP • 978-0-7603-0671-0  
\$17.99 US/\$22.50 CAN/£12.99 UK



### God, Honor, Fatherland

A Photo History of Panzergrenadier Division  
"Grossdeutschland" on the Eastern Front  
1942-1944  
Thomas McGuirl and Remy Spezzano  
Hardcover • 8.75 x 11.375 in  
226 pages • 387 color photos  
125590 AE • 978-0-96575-840-6  
\$49.95 US/\$55.00 CAN



### Guadalcanal

The U.S. Marines in World War II:  
A Pictorial Tribute  
Eric Hammel  
Hardcover • 9.25 x 10.875 in  
160 pages • 265 b/w photos  
145403 AP • 978-0-76033-148-4  
\$34.95 US/\$43.95 CAN/£25.00 UK



### Helmets of the ETO

A Historical and Technical Guide  
Regis Giard  
Hardcover • 9 x 12 in  
216 pages • 700 color photos  
180977 AE • 978-2-35250-062-9  
\$49.95 US/\$82.00 CAN



### Hitler's Alpine Retreat

James Wilson  
Paperback • 6.75 x 9.75 in  
208 pages • 250 b/w photos  
146177 AE • 978-1-84415-505-7  
\$24.95 US



### Hitler's Army

The Men, Machines, and Organization:  
1939-1945  
David Stone  
Hardcover • 9.76 x 11.61 in  
288 pages • 159 color & 188 b/w photos  
149561 AP • 978-0-7603-3750-9  
\$40.00 US/\$49.99 CAN

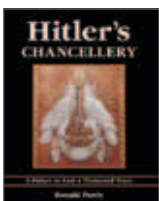

### Hitler's Chancellery

A Palace to Last a Thousand Years  
Ronald Pawly  
Hardcover • 7.5 x 9.5 in  
192 pages • 200 color & b/w photos  
150161 AE • 978-1-84797-091-6  
\$49.95 US/\$62.50 CAN



### Hitler's Master of the Dark Arts

Himmler's Black Knights and the Occult  
Origins of the SS  
Bill Yenne  
Hardcover • 7.25 x 9.25 in  
320 pages • 32 color & 51 b/w photos  
149591 AP • 978-0-7603-3778-3  
\$30.00 US/\$33.00 CAN/£20.00 UK



### Hitler's Pre-emptive War

The Battle for Norway, 1940  
Henrik Lunde  
Paperback • 6 x 9 in  
600 pages • b/w photos  
199895 AE • 978-1-93514-933-0  
\$19.95 US/\$21.99 CAN



### World War II Data Book Hitler's Secret Weapons

1933-1945  
David Porter  
Hardcover • 9.5 x 7.5 in  
192 pages • 150 color photos  
193790 AE • 978-1-90662-675-4  
\$34.95 US/\$38.99 CAN



### Hungary 1944-1945

The Panzers' Last Stand  
Philippe Guillemot  
Paperback • 7.5 x 7 in  
80 pages • 26 color photos  
199896 AE • 978-2-35250-155-8  
\$19.95 US/\$21.99 CAN



### I Was With Patton

First-Person Accounts of WWII In  
George S. Patton's Command  
D. A. Lande  
Hardcover • 6 x 9 in  
304 pages • color photos  
134565 AP • 978-0-7603-1071-7  
\$24.95 US/\$27.50 CAN/£16.99 UK



### Inferno

The Epic Life and Death Struggle of the USS  
Franklin in World War II  
Joseph A. Springer  
Hardcover • 6 x 9 in  
352 pages • 39 b/w photos  
144440 AP • 978-0-7603-2982-5  
\$24.95 US/\$29.95 CAN/£16.99 UK  
Paperback  
149857 AP • 978-0-7603-3976-3  
\$19.99 US/\$21.99 CAN/£14.99 UK



### Islands of Hell

The U.S. Marines in the Western Pacific,  
1944-1945  
Eric Hammel  
Hardcover • 10.5 x 12 in  
300 pages • 574 b/w photos  
149560 AP • 978-0-7603-3779-0  
\$50.00 US/\$62.50 CAN/£34.99 UK



### At War Iwo Jima Recon

The U.S. Navy at War, February 17, 1945  
Dick Camp  
Paperback • 8.25 x 10.625 in  
128 pages • 126 b/w photos  
144404 AP • 978-0-7603-2993-1  
\$24.95 US/\$27.50 CAN/£16.99 UK



### Kampfgruppe Peiper

The Race for the Meuse  
David Cooke and Wayne Evans  
Hardcover • 70 x 9.50 in  
224 pages • 100 b/w photos  
144970 AE • 978-1-84415-287-2  
\$32.95 US



### Khaki Drill & Jungle Green

British Tropical Uniforms 1939-45  
Martin J. Brayley and Richard Ingram  
Paperback • 8.25 x 12 in  
144 pages • 296 color photos  
150165 AE • 978-1-84797-109-8  
\$39.95 US/\$49.99 CAN



### At War M4 Sherman at War

Michael Green and James D. Brown  
Paperback • 8.25 x 10.625 in  
128 pages • 66 color & 78 b/w photos  
144197 AP • 978-0-7603-2784-5  
\$19.95 US/\$23.95 CAN/£12.99 UK



### Massacre at Malmedy

Charles Whiting  
Paperback • 6 x 9 in  
246 pages • b/w photos  
146727 AE • 978-1-84415-620-7  
\$24.95 US



### The MKB42, MP43, MP44 and the Sturmgewehr 44

Guus De Vries  
Hardcover • 9 x 9 in  
152 pages • 220 photos  
193816 AE • 978-9-08055-836-6  
\$39.95 US/\$43.99 CAN



### More Than Courage

Sicily, Naples-Foggia, Anzio, Rhineland,  
Ardennes-Alsace, Central Europe: The Combat  
History of the 504th Parachute Infantry  
Regiment in World War II  
Phil Nordyke  
Hardcover • 6 x 9 in  
480 pages • 64 b/w photos  
145618 AP • 978-0-7603-3313-6  
\$28.00 US/\$29.95 CAN/£16.99 UK



### Mountbatten of Burma

Captain of War  
Ian McGeoch  
Hardcover • 6 x 9 in  
288 pages • 30 b/w photos  
150042 AE • 978-1-84425-686-0  
\$34.95 US/\$43.99 CAN



### The MP38, 40, 40/1 and 41 Submachinegun

Guus De Vries  
Hardcover • 9 x 9 in  
152 pages • 220 photos  
193817 AE • 978-9-08055-832-8  
\$39.95 US/\$43.99 CAN

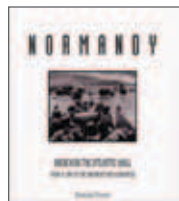

### Normandy

Breaching the Atlantic Wall: From D-Day to the  
Breakout and Liberation  
Dominique Francois  
Hardcover • 10.5 x 12 in  
300 pages • 100 color & 500 b/w photos  
145526 AP • 978-0-7603-3327-3  
\$50.00 US/\$55.00 CAN/£30.00 UK



### Normandy

A Graphic History of D-Day, The Allied Invasion  
of Hitler's Fortress Europe  
Wayne Vasant  
Paperback • 6 x 9 in  
104 pages  
200323 AP • 978-0-7603-4392-0  
\$19.99 US/\$21.99 CAN/£14.99 UK

Available September 2012



### Normandy '44 Operation Goodwood

Didier Lodieu  
Paperback • 8 x 9.5 in  
84 pages • color photos  
146688 AE • 978-2-35250-039-1  
\$19.95 US



### Normandy '44 Operations Totalize and Tractable

Normandy, August 1944  
Ludovic Fortin  
Paperback • 8 x 9.5 in  
84 pages • color photos  
146690 AE • 978-2-35250-053-7  
\$19.95 US

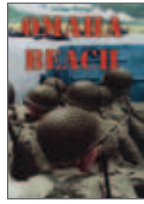

### Omaha Beach

Georges Bernage  
Paperback • 8.3 x 11.6 in  
160 pages • color photos  
199914 AE • 978-2-84048-287-1  
\$26.95 US/\$29.99 CAN



### Omaha Beach & Beyond

The Long March of Sergeant Bob Slaughter  
John Robert Slaughter and Alex Kershaw  
Paperback • 5.5 x 8.5 in  
288 pages • 43 b/w photos  
147306 AP • 978-0-7603-3734-9  
\$17.99 US/\$22.50 CAN/£12.99 UK



### Operation Bagration

The Destruction of Army Group Centre  
June-July 1944, A Photographic History  
Ian Baxter  
Hardcover • 9 x 12 in  
144 pages • 160 color photos  
146696 AE • 978-1-90603-309-5  
\$59.95 US



### Operation Goodwood

July 1944 A Corridor of Death  
Perry Moore  
Hardcover • 9 x 12 in  
176 pages • 170 color photos  
144902 AE • 978-1-87462-273-4  
\$69.95 US

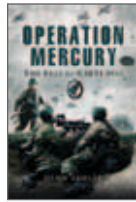

### Operation Mercury

The Fall of Crete 1941  
John Sadler  
Hardcover • 6.5 x 9.5 in  
256 pages • 140 b/w photo  
146259 AE • 978-1-84415-383-1  
\$39.95 US



### The Pacific Naval War 1941-1945

David Wragg  
Hardcover • 6 x 9.25 in  
224 pages • 16 b/w photos  
199915 AE • 978-1-84884-283-0  
\$39.95 US/\$43.99 CAN



### The Pacific War

The Strategy, Politics, and Players that  
Won the War  
William B. Hopkins  
Paperback • 6 x 9 in  
400 pages • 61 b/w photos  
149854 AP • 978-0-7603-3975-6  
\$22.99 US/\$24.99 CAN/£16.99 UK  
Hardcover  
145724 AP • 978-0-7603-3435-5  
\$30.00 US/\$32.95 CAN/£17.99 UK



### The Pacific War Day by Day

John Davison  
Hardcover • 8.75 x 11.25 in  
192 pages • color photos  
180555 BK • 978-0-78582-752-8  
\$12.99 US/\$14.99 CAN

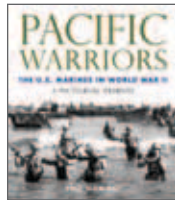

### Pacific Warriors

The U.S. Marines in World War II  
Eric Hammel  
Paperback • 9.625 x 11 in  
256 pages • 300 b/w photos  
149768 AP • 978-0-7603-3900-8  
\$24.99 US/\$31.99 CAN/£16.99 UK



### The Panzer Soldier

Wade Krawczyk  
Hardcover • 8.25 x 11.6875 in  
128 pages • 250 color & 50 b/w photos  
145108 AE • 978-1-86126-856-3  
\$34.95 US



### Panzers at War

Michael Green and Gladys Green  
Paperback • 8.25 x 10.625 in  
128 pages • 100 color photos  
139400 AP • 978-0-7603-2152-2  
\$19.95 US/\$21.95 CAN/£12.99 UK



### Posters of World War II

Allied and Axis Propaganda 1939 - 1945  
Peter Darman  
Hardcover • 9.75 x 11.25 in  
224 pages  
180782 BK • 978-0-78582-852-5  
\$14.99 US/\$16.99 CAN

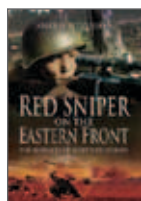

### Red Sniper on the Eastern Front

Joseph Pilyushin  
Hardcover • 6 x 9.5 in  
288 pages • 20 color photos  
193802 AE • 978-1-84884-120-8  
\$32.95 US/\$35.99 CAN



### Skorzeny's Special Missions

The Memoirs of Hitler's Most Daring Commando  
Otto Skorzeny and Charles Messenger  
Paperback • 5.5 x 8.5 in  
240 pages • 12 b/w photos  
149930 AP • 978-0-7603-4034-9  
\$16.99 US/\$18.99 CAN



### Sniper Ace

From Eastern Front to Siberia  
Bruno Sutkus  
Hardcover • 6 x 9 in  
256 pages • 50 pages b/w photos  
199923 AE • 978-1-84832-548-7  
\$49.95 US/\$35.99 CAN



### Soviet Tank Units 1939-45

The Essential Vehicle Identification Guide

David Porter

Hardcover • 7.5 x 9.5 in

192 pages • 250 color & b/w photos

180936 AE • 978-1-90662-631-0

\$34.95 US/\$43.99 CAN



### SS Totenkopf France 1940

Campaign Photo Diary of the Totenkopf Division  
May 1940

Eric Lefe'vre

Hardcover • 8 x 11 in

144 pages • 89 b/w photos

199924 AE • 978-2-35250-115-2

\$49.95 US/\$55.00 CAN



### Stalingrad

How the Red Army Survived the  
German Onslaught

Michael K. Jones and David M. Glantz

Hardcover • 6 x 9 in

266 pages • 16 b/w photos

146708 AE • 978-1-93203-372-4

\$32.95 US



### Stalin's War

Soviet Uniforms & Militaria 1941-45 in  
Colour Photographs

Laszlo Bekesi

Hardcover • 8.25 x 11.6875 in

144 pages • color photos

144024 AE • 978-1-86126-822-8

\$44.95 US



### Standard Military Motor Vehicles

War Department

Paperback • 5.125 x 8.5 in

590 pages • color photos

144113 AE • 978-1-85520-720-2

\$44.95 US/\$49.95 CAN



### Steeds of Steel

A History of American Mechanized Cavalry in World  
War II

Harry Yeide

Hardcover • 6 x 9 in

320 pages • 51 b/w photos

145640 AP • 978-0-7603-3360-0

\$27.95 US/\$30.95 CAN/£18.99 UK



### Steel Rain

Waffen-SS Panzer Battles in the West 1944-1945

Tim Ripley

Hardcover • 7.75 x 10.5 in

224 pages

180867 BK • 978-0-78582-868-6

\$12.99 US/\$14.99 CAN



### Steel Storm

Waffen-SS Panzer Battles on the Eastern Front  
1943-1945

Tim Ripley

Hardcover • 8 x 10.5 in

224 pages

180868 BK • 978-0-78582-869-3

\$12.99 US/\$14.99 CAN



### The Story of the SS

Hitler's Infamous Legions of Death

Nigel Cawthorne

Hardcover • 8.25 x 11.75 in

208 pages • color photos

180440 BK • 978-0-78582-714-6

\$12.99 US



### Surviving the Reich

The World War II Saga of a Jewish-American GI

Ivan L. Goldstein

Hardcover • 5.5 x 8.5 in

240 pages • 49 b/w photos

149631 AP • 978-0-7603-3816-2

\$26.00 US/\$32.50 CAN/£18.99 UK



### Tales From a Tin Can

The USS Dale from Pearl Harbor to Tokyo Bay

Michael Keith Olson

Paperback • 6 x 9 in

336 pages • 11 b/w photos

149652 AP • 978-0-7603-3826-1

\$17.99 US/\$19.99 CAN/£14.99 UK



### The Tank Killers

A History of America's World War II Tank  
Destroyer Force

Harry Yeide

Paperback • 6 x 9 in

339 pages • 16 b/w photos

146707 AE • 978-1-93203-380-9

\$18.95 US

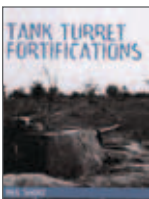

### Tank Turret Fortifications

Neil Short

Hardcover • 7.4375 x 9.6875 in

192 pages • 200 b/w photos

145100 AE • 978-1-86126-687-3

\$34.95 US

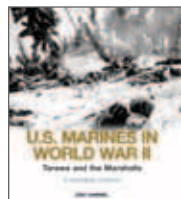

### U.S. Marines in World War II Tarawa and the Marshalls

A Pictorial Tribute

Eric Hammel

Hardcover • 9.25 x 10.875 in

160 pages • 255 b/w photos

145474 AP • 978-0-7603-3329-7

\$35.00 US/\$38.95 CAN/£17.99 UK



### The Third Reich Day By Day

Christopher Aillsby

Hardcover • 8.5 x 11 in

192 pages • color photos

180360 BK • 978-0-78582-665-1

\$12.99 US/\$14.99 CAN

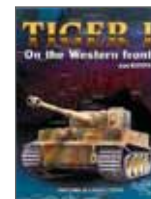

### Tiger 1 On the Western Front

Jean Restayn

Hardcover • 9.625 x 12.5 in

144 pages • 64 color & 250 b/w photos

131465 AE • 978-2-91390-313-5

\$55.00 US



**Spearhead  
Tiger Tank Battalions  
in World War II**

George Forty  
Paperback • 7.25 x 9.75 in  
128 pages • 25 color & 85 b/w photos  
144488 AP • 978-0-7603-3049-4  
\$21.99 US/\$23.95 CAN/£12.99 UK



**At War  
Tiger Tanks at War**

Michael Green and James D. Brown  
Paperback • 8.25 x 10.625 in  
128 pages • 111 color & 30 b/w photos  
144567 AP • 978-0-7603-3112-5  
\$21.99 US/\$27.50 CAN/£12.99 UK

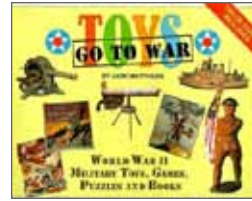

**Toys Go to War**

World War II Military Toys, Games,  
Puzzles and Books  
J. Matthews  
Paperback • 11 x 8.5 in  
264 pages • 538 color & 333 b/w photos  
121570 AE • 978-0-92952-195-4  
\$29.95 US/\$32.95 CAN



**U-Boote Crews**

The Day-to-Day Life Aboard Hitler's Submarines  
Jean Delize  
Hardcover • 9.5 x 12.5 in  
128 pages • color photos  
146694 AE • 978-2-35250-046-9  
\$39.95 US

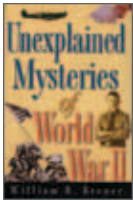

**Unexplained Mysteries of  
World War II**

William Breuer  
Hardcover • 6.5 x 9.5 in  
238 pages  
159390 BK • 978-0-78582-253-0  
\$9.99 US/\$10.99 CAN



**USMC Uniforms & Equipment  
1941-45**

Bruno Alberti  
Hardcover • 12.5 x 9.1 in  
144 pages • color photos  
146341 AE • 978-2-91523-999-7  
\$44.95 US



**At War  
USS Iowa at War**

Kit Bonner, Carolyn Bonner and  
Iowa Governor Tom Vilsack  
Paperback • 8.25 x 10.625 in  
128 pages • 115 color & 15 b/w photos  
144217 AP • 978-0-7603-2804-0  
\$19.95 US/\$24.95 CAN/£12.99 UK



**At War  
USS Missouri at War**

Kit Bonner and Carolyn Bonner  
Paperback • 8.25 x 10.625 in  
160 pages • 87 color & 103 b/w photos  
145469 AP • 978-0-7603-3219-1  
\$24.95 US/\$27.50 CAN/£14.99 UK



**Villers-Bocage**

Normandy 1944  
Henrik Marie  
Paperback • 8 x 11.5 in  
144 pages • color photos  
199929 AE • 978-2-84048-292-5  
\$26.95 US/\$29.99 CAN



**Voices of the Bulge**

Untold Stories from Veterans of the  
Battle of the Bulge  
Michael Collins and Martin King  
Hardcover w/DVD • 6.25 x 9.25 in  
320 pages • 98 b/w photos  
149929 AP • 978-0-7603-4033-2  
\$29.00 US/\$32.00 CAN/£20.00 UK



**Waffen-SS Uniforms  
& Insignia**

Wade Krawczyk  
Hardcover • 7.5 x 9.5 in  
128 pages • 200 color photos  
133959 AE • 978-1-86126-461-9  
\$44.95 US/\$49.99 CAN



**The Essential Vehicle  
Identification Guide  
Waffen-SS Divisions**

1939-45  
Chris Bishop  
Hardcover • 7.5 x 9.5 in  
192 pages • 280 photos  
146705 AE • 978-1-90570-455-2  
\$34.95 US



**Waffen-SS Kursk 1943,  
Volume 3, Archive Series**

Remy Spezzano  
Hardcover • 8 x 8 in  
112 pages • color photos  
138926 AE • 978-0-96575-847-5  
\$34.95 US



**Waffen-SS Kursk 1943,  
Volume 4, Archive Series**

Remy Spezzano  
Hardcover • 8.375 x 8.375 in  
112 pages • color photos  
138927 AE • 978-0-96575-848-2  
\$34.95 US



**Waffen-SS Kursk 1943,  
Volume 5, Archive Series**

Remy Spezzano  
Hardcover • 8 x 8 in  
112 pages • color photos  
138928 AE • 978-0-97483-890-8  
\$34.95 US



**Waffen-SS Uniforms  
In Color Photographs**

Europa Militaria Series #6  
Steven Amodio  
Paperback • 7.75 x 10.5 in  
66 pages • 100 color photos  
133474 AE • 978-1-86126-459-6  
\$21.95 US/\$23.99 CAN



### War Stories of the Battle of the Bulge

Michael Green and James D. Brown  
Hardcover • 6 x 9 in  
320 pages • 44 b/w photos  
147232 AP • 978-0-7603-3667-0  
\$28.00 US/\$30.00 CAN/£20.00 UK



### Wehrmacht Camouflage Uniforms

And Post-War Derivatives  
D. Peterson  
Paperback • 7.5 x 10.25 in  
64 pages • 124 color photos  
119954 AE • 978-1-85915-005-4  
\$21.95 US/\$23.95 CAN



### Western Allied Tanks 1939-45

The Essential Vehicle Identification Guide  
David Porter  
Hardcover • 7.5 x 9.5 in  
192 pages • 250 color & b/w photos  
180937 AE • 978-1-90662-632-7  
\$34.95 US/\$43.99 CAN



### The World War II 100

A Ranking of the Most Influential Figures of the Second World War  
Howard J. Langer  
Hardcover • 6.75 x 9.5 in  
336 pages  
159975 BK • 978-0-78582-366-7  
\$12.99 US/\$14.99 CAN



### World War II Fact & Quiz Book

Peter Darman  
Hardcover • 5.25 x 8.5 in  
304 pages  
180478 BK • 978-0-78582-736-8  
\$9.99 US/\$10.99 CAN



### The World War II GI

US Army Uniforms 1941-45 in Colour Photographs  
Richard Windrow and Tim Hawkins  
Paperback • 8.25 x 10 in  
144 pages • 280 color photos  
146686 AE • 978-1-84797-033-6  
\$29.95 US



### The World War II Tommy

British Army Uniforms, European Theatre 1939-45  
Martin Brawley  
Paperback • 8.25 x 11.6875 in  
144 pages • 250 color photos  
145929 AE • 978-1-86126-914-0  
\$24.95 US



### WW2 Jeep Military Portfolio

1941-1945  
R.M. Clarke  
Paperback • 8 x 10.75 in  
140 pages • 275 b/w photos  
119502 AE • 978-1-85520-217-7  
\$24.95 US/\$27.50 CAN

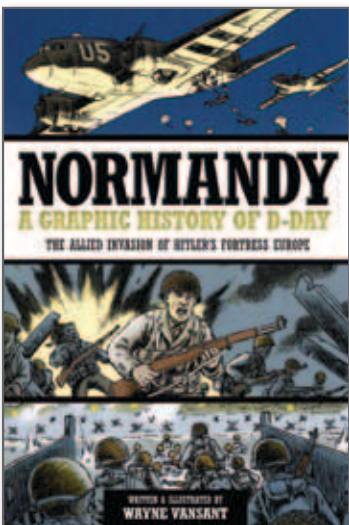

See Page 41

### Normandy

- As one of the most important events in the defining conflict of the last century, the epic history depicted in Normandy is constantly relevant to readers around the world.
- This is a serious book. Wayne's work has the level of details of a non-fiction print hardcover and will appeal to readers more interested in the detail of military history than fictionalized narratives.
- Besides the traditional bookstore market, Wayne has a following in the comic bookstore market. The library market has been one of the most receptive markets to graphic novels. Vansant's comics have been sold at National Historic Sites and *Normandy* would make an ideal product for any history museum or institution that touches on World War II.

# SPECIAL OPERATION FORCES



## 21st Century Sniper

The Weapons, the Technology, and the Strategies  
Brandon Webb

In this book, Webb covers the intensive training a sniper goes through to become a master of concealment and skill. This book is suitable for gun enthusiasts, outdoorsmen, the beginning sniper, and those with military backgrounds.

Paperback • 7 x 10 in  
320 pages • 50 color photos  
192807 AE • 978-1-61608-001-3  
\$17.95 US/\$22.50 CAN

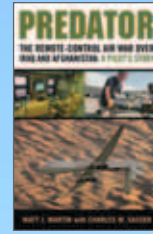

## Predator

The Remote-Control Air War over Iraq and Afghanistan:  
A Pilot's Story

Matt J. Martin and Charles W. Sasser

Martin is considered a "top gun" of unmanned aerial vehicles (UAVs). His story involves nearly every facet of the War on Terror: tracking Osama bin Laden; capturing top al-Qaeda leader al-Zarqawi; and rescuing workers kidnapped by the Taliban.

Hardcover • 5.75 x 8.75 in  
320 pages • 16 color photos  
149764 AP • 978-0-7603-3896-4  
\$28.00 US/\$30.00 CAN/£20.00 UK

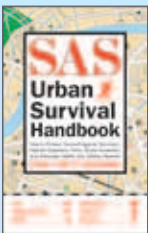

## SAS Urban Survival Handbook

How to Protect Yourself Against Terrorism, Natural Disasters, Fires, Home Invasions, and Everyday Health and Safety Hazards

John Wiseman

This book is a complete guide to survival in the urban jungle. From self-defense techniques to coping with natural disasters, this book will teach readers to recognize risks, make quick decisions, and live confidently in the modern urban world.

Paperback • 5.3 x 8.3 in  
640 pages • 100 color photos  
192782 AE • 978-1-60239-216-8  
\$17.95 US/\$22.50 CAN

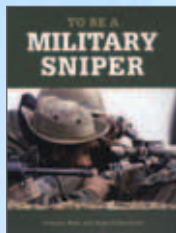

## To Be a Military Sniper

Gregory Mast and Hans Halberstadt

The training and character that make for success in one of the most challenging and mysterious jobs the military has to offer, clearly described and illustrated.

Paperback • 8.25 x 10.625 in  
144 pages • 217 color photos  
144437 AP • 978-0-7603-3002-9  
\$22.95 US/\$24.95 CAN/£14.99 UK

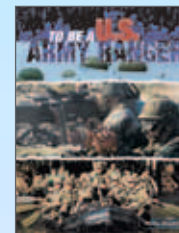

## To Be a U. S. Army Ranger

Russ Bryant

Experience the transformation of raw recruits as Iowa farm boys and ghetto hardened L.A. gang bangers are molded into one of the U.S. Army's most effective fighting units.

Paperback • 8.25 x 10.5 in  
160 pages • 150 color & 50 b/w photos  
135819 AP • 978-0-7603-1314-5  
\$24.99 US/\$31.99 CAN/£14.99 UK



## To Be a U. S. Navy Seal

Cliff Hollenbeck

*To Be A US Navy Seal* chronicles the 25-week training a Seal experiences.

Paperback • 8.25 x 10.5 in  
160 pages • color photos  
135938 AP • 978-0-7603-1404-3  
\$24.95 US/\$27.50 CAN/£12.99 UK

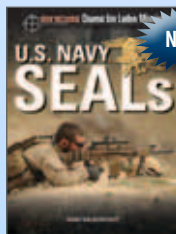

## U.S. Navy SEALs

Hans Halberstadt

This edition is updated and expanded to include activities and operations in Afghanistan as well as: The Osama bin Laden mission, SEALs at war, Counter-piracy ops, and Weapons and equipment.

Paperback • 8.25 x 10.625 in  
160 pages • 180 color & 13 b/w images  
194857 AP • 978-0-7603-4301-2  
\$24.99 US/\$27.99 CAN/£16.99 UK

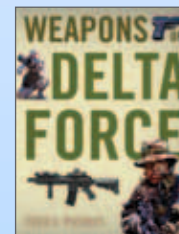

## Weapons of Delta Force

Fred Pushies

As America's elite counterterrorist organization, Delta Force uses some of the most sophisticated weapons in the field today. Pistols, sniper rifles, special mission aircraft, and paratrooper gear, and more are presented in this illustrated account.

Paperback • 8.25 x 10.625 in  
128 pages • 100 color & 100 b/w photos  
149650 AP • 978-0-7603-3824-7  
\$19.99 US/\$24.99 CAN/£14.99 UK

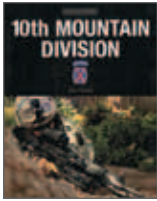

**Military Power  
10th Mountain Division**

Fred Pushies  
Paperback • 8.25 x 10.625 in  
128 pages • 115 color & 19 b/w photos  
145629 AP • 978-0-7603-3349-5  
\$19.99 US/\$21.95 CAN/£12.99 UK



**Military Power  
82nd Airborne**

Fred Pushies  
Paperback • 8.25 x 10.625 in  
128 pages • 109 color & 25 b/w photos  
145643 AP • 978-0-7603-3465-2  
\$19.99 US/\$21.95 CAN/£12.99 UK



**Military Power  
82nd Airborne Division**

1917-2005  
Dominique Francois  
Hardcover • 9 x 12 in  
400 pages • color photos  
144901 AE • 978-2-84048-215-4  
\$65.00 US

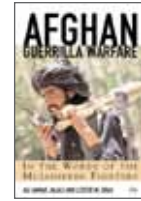

**Afghan Guerrilla Warfare**  
In the Words of the Mujahideen Fighters

Ali Ahmad Jalali  
Paperback • 6 x 9 in  
448 pages • 100+ b/w photos  
135000 AP • 978-0-7603-1322-0  
\$17.99 US/\$22.50 CAN/£12.99 UK



**Hunting al Qaeda**

A Take-No-Prisoners Account of Terror,  
Adventure, and Disillusionment  
Anonymous  
Paperback • 6 x 9 in  
256 pages • 64 b/w photos  
147308 AP • 978-0-7603-3736-3  
\$17.99 US/\$22.50 CAN/£12.99 UK



**Illustrated Manual of  
Sniper Skills**

Mark Spicer  
Paperback • 6 x 9 in  
256 pages • 250 color  
143034 AP • 978-0-7603-2674-9  
\$22.99 US/\$24.95 CAN/£13.99 UK



**Into the Viper's Nest**

The First Pivotal Battle  
of the Afghan War  
Stephen Grey  
Hardcover • 6.25 x 9.25 in  
352 pages • 25 b/w photos  
149765 AP • 978-0-7603-3897-1  
\$28.00 US



**Military Power  
Screaming Eagles**

101st Airborne Division  
Russ Bryant and Susan Bryant  
Paperback • 8.25 x 10.625 in  
128 pages • 124 color & 30 b/w photos  
144428 AP • 978-0-7603-3122-4  
\$21.99 US/\$23.95 CAN/£14.99 UK



**The Secret Team**

The CIA and Its Allies in Control of the United  
States and the World  
L. Fletcher Prouty  
Paperback • 5.4 x 8.3 in  
480 pages • no photos  
192783 AE • 978-1-60239-229-8  
\$14.95 US/\$18.99 CAN



**To Be a Paratrooper**

Gregory Mast and Hans Halberstadt  
Paperback • 8.25 x 10.625 in  
144 pages • 198 color & 29 b/w photos  
144502 AP • 978-0-7603-3046-3  
\$21.95 US/\$26.95 CAN/£12.99 UK



**To Be a U.S. Army  
Green Beret**

Gerry Schumacher  
Paperback • 8.25 x 10.625 in  
160 pages • 150 color & 50 b/w photos  
139303 AP • 978-0-7603-2107-2  
\$22.99 US/\$28.99 CAN/£14.99 UK

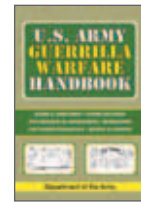

**U.S. Army Guerrilla  
Warfare Handbook**

Department Of The Army  
Paperback • 5.5 x 8.2 in  
264 pages • 45 b/w photos  
192790 AE • 978-1-60239-374-5  
\$12.95 US/\$16.50 CAN



**U.S. Army Ranger Handbook**

Department Of The Army  
Paperback • 5.5 x 8.2 in  
176 pages • b/w photos  
192794 AE • 978-1-60239-052-2  
\$12.95 US/\$16.50 CAN



**The U.S. Navy SEAL Guide to  
Fitness and Nutrition**

U.S. Navy  
Paperback • 8.5 x 11 in  
480 pages • b/w photos  
192800 AE • 978-1-60239-030-0  
\$16.95 US/\$18.99 CAN



# USMC

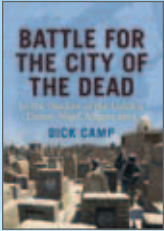

### Battle for the City of the Dead

In the Shadow of the Golden Dome, Najaf, August 2004

Dick Camp

In August of 2004, a Shiite cleric named Muqtada Al-Sadr called upon the Mahdi Militia, to resist the American occupation in Iraq. This book chronicles the U.S. forces fight in 120-degree heat through a tangle of crypts, mausoleums, and graves.

Hardcover • 6.25 x 9.25 in

320 pages • 142 color photos

149894 AP • 978-0-7603-4006-6

\$30.00 US/\$33.00 CAN/£20.00 UK

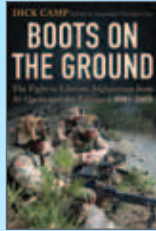

### Boots on the Ground

The Fight to Liberate Afghanistan from Al-Qaeda and the Taliban, 2001-2002

Dick Camp

*Boots on the Ground* is a narrative account of the American war to free Afghanistan from al Qaeda and the Taliban. Camp's exciting narrative covers the origins of American combat involvement in the country as well as the post-9/11 campaigns.

Hardcover • 6.25 x 9.25 in

320 pages • 121 color & 6 b/w photos

193292 AP • 978-0-7603-4111-7

\$30.00 US/\$33.00 CAN/£20.00 UK



### MARSOC

U.S. Marine Corps Special Operations Command

Fred Pushies

*MARSOC* is steeped in the heritage of the Marine Raiders of World War II, Force Reconnaissance companies of Vietnam, and Detachment-One, which stood up after the attacks on 9/11. Their mission is to win wars before they begin.

Paperback • 8.25 x 10.625 in

160 pages • 118 color & 49 b/w photos

193312 AP • 978-0-7603-4074-5

\$24.99 US/\$27.99 CAN/£16.99 UK

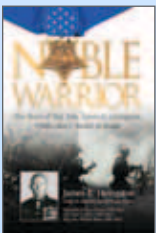

### Noble Warrior

The Story of Maj. Gen. James E. Livingston, USMC (Ret.), Medal of Honor

Maj. Gen. James E. Livingston, Colin D. Heaton, Anne-Marie Lewis, Gen. Al Gray, USMC (Ret.), 29th Commandant, Brig. Gen. William Weise, USMC (Ret.) and Gen. Paul X. Kelley, USMC (Ret.), 28th Commandant

Major General James E. Livingston received the Congressional Medal of Honor for his role as an infantry company commander at Dai Do, Vietnam. His remarkable life and career is recounted in a book.

Hardcover • 5.5 x 8.5 in

272 pages • 30 b/w photos

149632 AP • 978-0-7603-3807-0

\$28.00 US/\$30.00 CAN/£20.00 UK

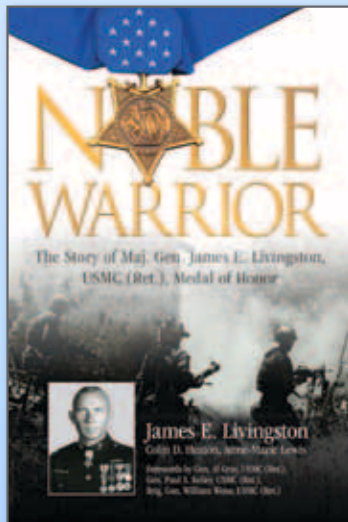

### Noble Warrior

• Author is Medal of Honor winner.

• Vietnam service included combat during the period of the heaviest fighting of the war in 1967 and 1968.

• Author was personally involved in Operation Frequent Wind, the 1975 evacuation of Saigon.

"Marine leaders and those who seek to lead will surely benefit from this book. The often blunt, direct style is refreshing and makes it an easy read. The pearls of wisdom are there as is the dramatic battle leadership examples."

— *Leatherneck Magazine*

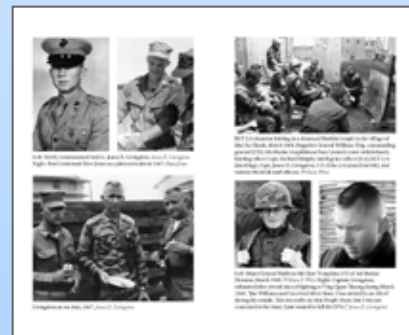



**Spearhead  
1st Marine Division  
in Vietnam**

Simon Dunstan  
Paperback • 7.25 x 9.75 in  
128 pages • 25 color & 85 b/w photos  
144578 AP • 978-0-7603-3159-0  
\$21.99 US/\$23.95 CAN/£12.99 UK



**Chosin**  
Heroic Ordeal of the Korean War

Eric Hammel  
Paperback • 6 x 9 in  
480 pages • 12 color photos  
144383 AP • 978-0-7603-3154-5  
\$22.99 US/\$28.99 CAN/£14.99 UK



**The Devil Dogs at  
Belleau Wood**

U.S. Marines in World War I  
Dick Camp  
Paperback • 8.25 x 10.625 in  
128 pages • 167 color & 30 b/w photos  
144602 AP • 978-0-7603-3189-7  
\$19.95 US/\$21.95 CAN/£12.99 UK



**Heart for the Fight**  
A Marine Hero's Journey from the Battlefields of  
Iraq to Mixed Martial Arts Champion

Brian Stann and John R. Bruning  
Hardcover • 5.75 x 8.75 in  
320 pages • 28 color photos  
149767 AP • 978-0-7603-3899-5  
\$28.00 US/\$30.00 CAN/£20.00 UK

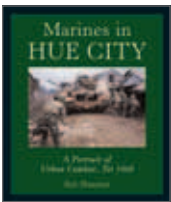

**Marines in Hue City**

A Portrait of Urban Combat, Tet 1968  
Eric Hammel  
Hardcover • 9.25 x 10.875 in  
168 pages • 117 color & 188 b/w photos  
143001 AP • 978-0-7603-2521-6  
\$34.95 US/\$44.95 CAN/£25.00 UK



**McCoy's Marines**

Darkside to Baghdad  
John Koopman  
Paperback • 6 x 9 in  
304 pages • 32 color photos  
147310 AP • 978-0-7603-3738-7  
\$17.99 US/\$22.50 CAN/£12.99 UK



**Operation Phantom Fury**

The Assault and Capture of Fallujah, Iraq  
Dick Camp  
Hardcover • 6 x 9 in  
320 pages • 102 color photos  
147268 AP • 978-0-7603-3698-4  
\$30.00 US/\$37.50 CAN/£18.99 UK



**Road of 10,000 Pains**

The Destruction of the 2nd NVA Division by the  
U.S. Marines, 1967  
Otto J. Lehrack and General Alfred M. Gray,  
Jr., 29th Commandant of the Marine Corps  
Hardcover • 6 x 9 in  
320 pages • 79 b/w photos  
149615 AP • 978-0-7603-3801-8  
\$30.00 US/\$37.50 CAN/£20.00 UK



**Search and Destroy**

The Story of an Armored Cavalry Squadron in  
Vietnam: 1-1 Cav, 1967-1968  
Keith W. Nolan  
Hardcover • 6 x 9 in  
448 pages • 38 b/w photos  
145617 AP • 978-0-7603-3312-9  
\$30.00 US/\$33.00 CAN/£20.00 UK



**Special Forces at War**

An Illustrated History, Southeast Asia 1957-1975  
Shelby L. Stanton and Major General Michael  
D. F. Healy, U.S. Army (Ret.)  
Hardcover • 8.875 x 11.875 in  
384 pages • 26 color & 1,064 b/w photos  
145737 AP • 978-0-7603-3449-2  
\$40.00 US/\$44.00 CAN/£25.00 UK



**To Be a U.S. Marine**

S.F. (Steve) Tomajczyk  
Paperback • 8.25 x 10.75 in  
160 pages • color photos  
137415 AP • 978-0-7603-1788-4  
\$24.99 US/\$31.99 CAN/£14.99 UK



**U.S. Marine Guidebook**

U.S. Marine Corps  
Paperback • 6 x 9 in  
432 pages • 85 b/w photos  
192799 AE • 978-1-60239-941-9  
\$14.95 US/\$18.99 CAN



**Military Power  
USMC**

Russ O. Bryant and W. David Perks  
Paperback • 8.3125 x 10.625 in  
128 pages • 80 color & 20 b/w photos  
143027 AP • 978-0-7603-2532-2  
\$21.99 US/\$23.95 CAN/£14.99 UK



**Wounded Soldier,  
Healing Warrior**

A Personal Story of a Vietnam Veteran Who Lost  
his Legs but Found His Soul  
Allen Clark and Ross Perot  
Hardcover • 6 x 9 in  
320 pages • 33 b/w Photos  
144532 AP • 978-0-7603-3113-2  
\$27.00 US/\$29.95 CAN/£16.99 UK

# INDEX

1st Marine Division in Vietnam	49	Boeing	19	FBI 100 Years	28	History of Remington Firearms, The	33
3rd Air Division 8th Air Force USAAF 1942-45	9	Boeing 707, KC-135	19	Feldbluse	39	Hitler's Alpine Retreat	40
4th Armored Division in World War II	38	Boeing 747	18, 22	Fighting Men of World War II Allied Forces	39	Hitler's Army	40
5th Airforce, The	9	Boeing 787 Dreamliner	18	Fighting Men of World War II Axis Forces	39	Hitler's Chancellery	40
8th Air Force	9	Boeing B-17 and B-29 Fortress and Superfortress Portfolio	9	Fighting Patton	36	Hitler's Master of the Dark Arts	40
9th Air Force	9	Boeing B-17 Flying Fortress	7	First Bull Run	28	Hitler's Pre-emptive War	40
10th Mountain Division	47	Bombers of the Imperial Japanese Army	9	Flight of the Mew Gull, The	20	Hitler's Secret Weapons	40
21st Century Sniper	46	Bombs Away!	7	Flights of Terror	20	HMS Victory	25
60 Years Of Combat Aircraft	15	Boots on the Ground	48	Fly Navy	2	How to Draw and Paint Aircraft Like a Pro	20
82nd Airborne	47	Bristol Beaufighter	10	Flying Cars	18	Hundred Feet Over Hell, A	2
82nd Airborne Division	47	Bristol's Bastards	28	Flying Guns of World War I	16	Hungary 1944-1945	41
101st Airborne	36	British Aircraft Corporation	16	Flying Guns World War II	10	Hunting al Qaeda	47
Advanced Aviation Modelling	24	British Post-War Jungle Webbing	33	Flying Helicopters	20	I Was With Patton	41
Aerobatic Teams	16	British Web Equipment of the Two World Wars	38	Flying Instructor's Patter Manual, The	21	Illustrated Directory of Guns, The	33
Aerobatics	19	Building, The	28	Flying Legends of World War II	10	Illustrated Directory of Warships, The	26
Aérospatiale-Bac Concorde	18	Burt Rutan's Race to Space	23	Flying Radio-Controlled Model Aircraft	24	Illustrated History of Firearms, The	32
Afghan Guerrilla Warfare	47	Buying and Selling Wartime Collectables	38	Flying the Airbus A380	20	Illustrated Manual of Sniper Skills	47
Air Force	16	Camouflage Uniforms	33	Flying the Big Jets	20	Immelmann	16
Air Force of the Imperial Japanese Navy, Volume 2, The	9	Centurion Tank, The	28	Flying the SR-71 Blackbird	2, 6	Infantry Attacks	27, 31
Air Force of the Japanese Imperial Navy, The	9	Cessna 172	18	Focke Wulf FW 190	10	Inferno	26, 41
Air Force One	15	Chosin	49	Focke-Wulf Fw 190 Dora, The	10	Instrument Procedures Handbook	22
Air Traffic Control Handbook	19	Churchill's Secret Weapons	38	Fortress Ploesti	10	International Rescue Thunderbirds	24
Airbus	19	Civil War Day By Day	28, 31	Fortress Rabaul	36	Into the Viper's Nest	47
Airbus A380	19	Civil War Weapons	32	Four Stars of Valor	39	Islands of Hell	41
Aircraft Inspection and Repair	21	Classic Aircraft	19	Fujita Plan, The	39	Iwo Jima	36
Airplane Flying Handbook	21	Classic American Airlines	19	G.I. Collector's Guide	39	Iwo Jima Recon	41
Alaska Bush Pilot Chronicles, The	18	Classic Fighters	16	G.I. Collector's Guide Volume 2	39	Japanese Army Air Force Fighter Units and Their Aces	11
All American, All the Way	38	Classic Ships	26	German & Austrian Aircraft of the First World War	16	Japanese Military Aircraft, Aircraft of the Imperial Japanese Navy	11
All Americans in World War II, The	38	Clausewitz Delusion, The	28	German Aces Speak, The	7	Japanese Naval Air Force Fighter Units And Their Aces, 1932-1945	11
Allied Bombers 1939-45	9	Cold War Legacy, A	28	German Air Projects	10	Japanese Special Attack Aircraft & Flying Bombs	11
Allied Liberation Vehicles	38	Cold War, The	28	German Anti-Tank Weapons	39	Jet Engines	20
Allied Rotocraft of the WW2 Period	9	Complete Illustrated Manual of Handgun Skills, The	32, 35	German Army Uniforms of World War II	39	Jimmy Stewart	7
America's Fighting Admirals	38	Concorde	19	German Automatic Weapons of World War II	36	Kaiser's U-Boote	26
America's Postwar Luxury Liners	26	Corsair 1940-1970	7	German Infantry in World War II	40	Kamikazes, Corsairs, and Picket Ships	11
American Aircraft Factory in World War II, The	9	Curtis Hawk H-75	10	German Military Equipment WW2	40	Kampgruppe Peiper	41
American Battleships	38	Custer and the Little Bighorn	28	German Mountain Army Mountain Soldier of WWII, The	40	KGB's Poison Factory, The	29
American Missiles	4	D-Day and the Battle of Normandy	38	German Panzer Markings	40	Khaki Drill & Jungle Green	41
American Paratrooper Helmets	38	D-Day Normandy	39	German Panzers in World War II	40	King of Airfighters	16
American Web Equipment: 1910 -1967	32	D-Day Paratroopers Volume 1	39	German Tanks of World War II in Color	40	Knight of Germany	16
American Web Equipment: 1967 -1991	32	Dam Busters	10	German Wars, The	28	Koga's Zero	11
American X & Y Planes	4	Dam Busters, The	10	German Warfare, The	16	Kugisho E14Y Glen	11
Anytime, Baby!	4	De Havilland Comet	19	Glassfibre Handbook, The	21	Last Confederate General, The	29
Art of War, The	28	De Havilland Moths In Detail	10	Glider Flying Handbook	22	Last Days of the Luftwaffe	11
Assault Rifle	33	De Havilland Tiger Moth	10	God, Honor, Fatherland	40	Last Man Standing	37
Attack on Pearl Harbor, The	38	Deutsche Soldaten	39	Great Warbow, The	33	Leave No Man Behind	16
Autogiro	19	Development of Jet and Turbine Aero Engines, The	4	Grumman F-14 Tomcat	2	Liberators in England in World War II	11
Aviation Instructor's Handbook	21	Devil Dogs at Belleau Wood, The	49	Guadalcanal	40	Lincoln's Admiral	29
Aviation Weather Services Handbook	21	Douglas A-4 Skyhawk	4	Guns of the Civil War	32, 35	Lockheed Constellation	18
Aviation Weather Services Handbook, 2nd Edition	21	Douglas DC-3 Dakota	7, 17	Half-Ton Military Land Rover, The	28	Longbow	33
Avro	16	Douglas Propliners	18, 22	Hardest Day, The	10	Lost Victories	37
Avro Lancaster	9	Eighth Air Force Bomber Stories	10	Hawker Hurricane	11	Loud and Clear	4
Avro Vulcan	2	Empire Flying Boat Manual	19	Hawker Siddeley/BAe Harrier	4	M 16, The	33
B-52 Stratofortress	2, 3	Encyclopedia of AFVs of WWII Volume 1	39	Heart for the Fight	49	M-1 Carbine, The	33
Balloon Flying Handbook	21	Encyclopedia of Civil War Usage, The	28	Heinkel HE 162 "Volksjager"	11	M2/M3 Bradley at War	29
Basic Aerobatics	19	Encyclopedia of Elite Forces in the Second World War	39	Helicopter Pilot's Companion, The	20	M4 Carbine	33
Battle for the City of the Dead	48	Encyclopedia of Soviet Fighters 1939-1951	16	Helicopter Pilot's Manual Volume 2, The	20	M4 Sherman at War	41
Battle of Britain Pilot	9	Enemy I Knew, The	39	Helicopter Pilot's Manual Volume 3, The	20	Machine Gun	33
Battle of the Bulge, The	36	English Electric Lightning	4	Helicopter Pilot's Manual, The	20	Main Battle Tanks	29
Battles of the Bible	28	Erich Von Manstein	39	Hell Hawks!	7, 14	Mannock	16
Bell P-39 Airacobra	9	F-100 Super Sabre at War	4	Helmets of ETO	40	Maps of Gettysburg, The	27
BF 109 Late Versions	9	F-14 Tomcat	4	Henschel Hs 126	11	Marines in Hue City	49
Bismarck	36	F-15 Eagle at War	4	Henschel Hs 129	11	MARSOC	48
Black Fokker Leader	16	F-16 A and B Versions	4	Herman Göring Fighter Ace	16	Massacre at Malmedy	41
Black Tuesday Over Namsi	4	F6F Hellcat at War	10	Historical Atlas of of the World At War, The	29	Matthew B. Brady	29
Blood Red Snow	36	Fairey Swordfish and Albacore	10	Historical Atlas of Weaponry, The	33	McCoy's Marines	49
Blood, Steel, & Myth	38	Faster Than Sound	19	History of Handguns, A	33	McDonnell F-4 Phantom	4
Bloody Triangle, The	38						
Blue Sea of Blood, A	38						

McDonnell Douglas F-4 Phantom	2	Photographic History of the Civil War,	5	U.S. Army Weapons Systems 2010-2011	34
ME 262 Stormbird, The	7, 14	Volume 5, The	30	U.S. Marine Guidebook	49
Medieval Military Costume	33	Piercing the Fog of War	30	U.S. Navy SEAL Guide to Fitness and	
Messerschmitt Me 163B Komet	11	Pilot's Handbook of Aeronautical Knowledge	22	Nutrition, The	47
Messerschmitt BF109	12	Pilot's Weather	20	U.S. Navy SEALs	25, 46
Messerschmitt Me 110 From 1939 to 1945	12	Pirates and Privateers	30	U.S.A.F. Tactical Reconnaissance in the Cold War	5
Messerschmitt Me 262	12	Planes of the RAF	17	Ultimate Guide to U.S. Army Combat	
Meteorology For Pilots	20	Plough & Scatter	30	Skills, Tactics, and Techniques, The	34
Microflight Pilot's Handbook	20	Post-War US Navy Air Carriers	5	Unblinking	3, 6
MIG Menace Over Korea	4	Posters of World War II	42	Unexplained Mysteries of World War II	44
Mighty Fortress, A	12	Predator	46	USAAF Airman, The	13
Mikoyan-Gurevitch MIG 21	5	Profiles of Flight V Bombers	5	USAAF Fighter Stories	13
Military & Civilian Amphibians 1940-90	29	Radio Control Foam Modelling	24	USMC	49
Military Aviation Disasters	17	Radio Controlled Helicopters -2 Edition	24	USMC Uniforms & Equipment 1941-45	44
Military Jeep	37	RAF Typhoon	5	USS Iowa at War	44
Military Land Rover	29	Rank and Rate	30	USS Missouri at War	44
Mirage III-C	5	Red Arrows	5	V-Bombers	6
Mission to Berlin	8	Red Arrows in Camera	5	Vickers Wellington	13
Mission to Tokyo	8	Red Baron, The	17	Victory at Risk	30
MKB42, MP43, MP44 and the		Red Baron's Last Flight, The	17	Vikings, The	34
Sturmgewehr 44, The	41	Red Sniper on the Eastern Front	42	Villers-Bocage	44
Modern Body Armour	32	Republic P-47 Thunderbolt "Bubbletop"	12	Vintage Aircraft Nose Art	8, 15
Modern British Webbing Equipment	33	RMS Titanic	25	Vintage Years of Airfix Box Art, The	24
Modern Warships	26	Road of 10,000 Pains	49	Viper Force	3
More Than Courage	41	Roman Legions Recreated In Color		Voices of the Bulge	44
Most Dangerous Enemy, The	12	Photographs, The	34	Voodoo Warriors	6
Mountbatten of Burma	41	Rotorcraft Flying Handbook	22	Waffen SS Uniforms & Insignia	44
MP38, 40, 40/1 and 41 Submachinegun, The	41	Royal Enfield	32	Waffen-SS Divisions	44
Naked in Da Nang	2	Royal Marines Fitness Manual	30	Waffen-SS Kursk 1943, Volume 3,	
Naked Pilot, The	20	Rupert Red Two	5	Archive Series	44
NASA Apollo 11	23	Sagittarius Rising	17	Waffen-SS Kursk 1943, Volume 4,	
NASA Space Shuttle	23	Samurai Battles	30	Archive Series	44
Native Americans & the Wild West in 3D:		Samurai Swords	34	Waffen-SS Kursk 1943, Volume 5,	
A Look Back in Time	29	Samurai, The	34	Archive Series	44
No Need to Die	12	SAS Urban Survival Handbook	46	Waffen-SS Uniforms In Color Photographs	44
Noble Warrior	48	Scale Aircraft for Free Flight	24	War in Pacific Skies	8
Normandy	41, 45	Scale Aircraft Modelling	24	War Stories of the Battle of the Bulge	45
Normandy '44 Operation Goodwood	41	Scale Military Figure Conversions	24	War Stories of the Infantry	30
Normandy '44 Operations Totalize		Scale Military Vehicle Conversions	24	War Stories of the Tankers	31
and Tractable	42	Schneider Trophy to Spitfire	21	Warbird Legends	8, 14
North American F-86 Sabre	2, 17	Screaming Eagles	47	Warbirds	17
North American P-51 Mustang	8	Seapower	25	Wars that Changed the World	31
North American P-51 Mustang	12	Search and Destroy	49	Warsaw Pact Badges	35
North American P-51D Mustang	12	Secret Team, The	47	Way of the Samurai, The	31
Nuclear Express, The	29	Sharks of the Air	8	We're Here to Win the War for You	13
Omaha Beach	42	Sherman Tank	35, 37	Weapons of Delta Force	46
Omaha Beach and Beyond	42	Silhouette Handbook of United States		Wehrmacht Camouflage Uniforms	45
One Giant Leap	23	Army Airforces Airplanes	12	Western Allied Tanks 1939-45	45
Operation Bagration	42	Skorzeny's Special Missions	42	What We Need	31
Operation Goodwood	42	Sky My Kingdom, The	12	When Art Keep 'Em Flying	13
Operation Mercury	42	Sling and the Stone, The	27	Winged Victory	17
Operation Phantom Fury	49	Sniper Ace	42	Wings of the Black Cross Number Five	14
Outdoor Survival	29	Sniping	30	Wings of the Black Cross Number Four	13
P-40 Curtiss	24	So Terrible a Storm	26	Wings of the Black Cross Number One	13
Pacific Naval War 1941-1945, The	42	Soaring Pilot's Manual, The	21	Wings of the Black Cross Number Six	14
Pacific War Day by Day, The	42	Soldier from Independence, The	30	Wings of the Black Cross Number Three	13
Pacific War, The	42	Soldiers' Accoutrements of the British		Wings of the Black Cross Number Two	13
Pacific Warriors	42	Army 1750-1900	34	Wings Over The Desert	14
Panzer Soldier, The	42	Sound Barrier	21	World Air Power Guide, The	6
Panzers at War	42	Soviet Military and Paramilitary Services:		World War II 100, The	45
Paramotoring From The Ground Up	20	Female Uniforms 1941-1991	34	World War II Day By Day	37
Patton's Third Army in World War II	37	Soviet Tank Units 1939-45	43	World War II Fact & Quiz Book	45
Petlyakov Pe-2 'Peshka'	12	Soviet Uniforms & Militaria 1917 - 1991	34	World War II GI, The	45
Photographic History of the Civil War,		Space Shuttle, The	23	World War II Tommy, The	45
Volume 1, The	29	SpaceShipOne	23	World's Greatest Aircraft, The	17
Photographic History of the Civil War,		Special Forces at War	49	World's Top 500 Airports, The	21
Volume 2, The	29	Special Ops, 1939-1945	30	Wounded Soldier, Healing Warrior	49
Photographic History of the Civil War,		Spitfire Manual 1940	12	WW2 Jeep Military Portfolio	45
Volume 3, The	29	Spitfire Story, The	12	Yakovlev YAK-23	6
Photographic History of the Civil War,		Spy's Journey, A	30	Yellow 10	14
Volume 4, The	29	Spycamera: The Minox Story	30		
		SR-71 Blackbird	5		
		SR-71 Revealed	5		
		SS Great Britain	25		
		SS Totenkopf France 1940	43		
		Stalin's War	43		
		Stalingrad	43		
		Standard Military Motor Vehicles	43		
		Star of Africa, The	8		
		Stars of the Sky, Legends All	21		
		Stealth Fighter	3		
		Steeds of Steel	43		
		Steel Rain	43		
		Steel Storm	43		
		Stonewall Brigade in the Civil War, The	30		
		Stormbird Colors	12		
		Story of the Boeing Company,			
		Updated Edition, The	15		
		Story of the SS, The	43		
		Stratofortress	5		
		Sub-Machine Gun	32		
		Successful Composite Techniques	21		
		Sukhoi Su-25 Frogfoot	5		
		Supermarine Seafire	12		
		Supermarine Spitfire	13		
		Survive the Bomb	27		
		Surviving the Reich	43		
		Swashbucklers and Black Sheep	6, 8		
		Take Off	24		
		Tales From a Tin Can	43		
		Tank Killers, The	43		
		Tank Turret Fortifications	43		
		Tanks	27		
		Tarawa and the Marshalls	43		
		Terrain Modeling	24		
		Terror of the Autumn Skies	15		
		Third Reich Day By Day, The	43		
		Through Blue Skies to Hell	13		
		Through the Eyes of the World's Fighter Aces	13		
		Tiger 1 on the Western Front	43		
		Tiger Tank	27, 37		
		Tiger Tank Battalions in World War II	44		
		Tiger Tanks at War	44		
		Timechart History of The Civil War, The	30		
		Tin Hats to Composite Helmets	34		
		Titanic	26		
		Titanic Triumph and Tragedy	26		
		Titanic: Destination Disaster	25		
		To Be a Military Sniper	46		
		To Be a Paratrooper	47		
		To Be a Pilot	21		
		To Be a U. S. Army Ranger	46		
		To Be a U. S. Navy Seal	46		
		To Be a U.S. Army Green Beret	47		
		To Be a U.S. Marine	49		
		To Be an Airline Pilot	21		
		To War With The Yoxford Boys	13		
		Tommy's War	34		
		Toys Go to War	44		
		TSR2	3		
		Turbojet	5		
		Two-Man Air Force	13		
		U-Boote Crews	44		
		U.S. 86th Fighter Group in WWII	13		
		U.S. Air Force Survival Handbook	5		
		U.S. Army Explosives and			
		Demolitions Handbook	34		
		U.S. Army Guerrilla Warfare Handbook	47		
		U.S. Army Guide to Booby Traps	34		
		U.S. Army Hand-to-Hand Combat	34		
		U.S. Army Ranger Handbook	47		
		U.S. Army Survival, Evasion, and Recovery	34		

# Calendars



## **Flying Legends 2013**

John M. Dibbs

17 x 12 in, 28 pages, Wall

14 color & 13 b/w photos

Item # 194865 AC • ISBN: 978-0-7603-4308-1

**\$14.99 US/\$17.99 CAN**



## **Air Superiority 2013**

John M. Dibbs

17 x 12 in, 28 pages, Wall

27 color photos

Item # 194864 AC • ISBN: 978-0-7603-4307-4

**\$14.99 US/\$17.99 CAN**

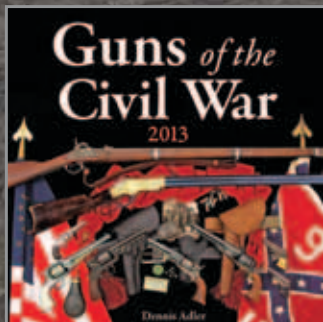

## **Guns of the Civil War 2013**

Dennis Adler

12 x 12 in, 24 pages, Wall

color photos

Item # 194937 AC • ISBN: 978-0-7603-4355-5

**\$13.99 US/\$16.99 CAN**



## **U.S. Navy SEALs 2013**

12 x 12 in, 24 pages, Wall

18 color photos

Item # 194938 AC • ISBN: 978-0-7603-4356-2

**\$13.99 US/\$16.99 CAN**



## **QUAYSIDE PUBLISHING GROUP**

400 FIRST AVENUE NORTH, SUITE 300

MINNEAPOLIS, MN 55401

(800)328-0590 • [WWW.QUAYSIDEPUBLISHINGGROUP.COM](http://WWW.QUAYSIDEPUBLISHINGGROUP.COM)

ITEM # 210758

ISBN: 978-0-7603-4417-0