

THE
*Pointless
Book*

STARTED BY ALFIE DEYES
FINISHED BY YOU



© 2014 Alfie Deyes

**Text © 2014 Alfie Deyes
All images © Shutterstock**

**First published in the UK in 2014 by Blink Publishing
an imprint of the Bonnier Publishing Group**

**First published in the United States in 2014
by Running Press Book Publishers
A Member of the Perseus Books Group**

**All rights reserved under the Pan-American and
International Copyright Conventions**

Printed in the United States of America

This book may not be reproduced in whole or in part, in any form or by any means, electronic or mechanical, including photocopying, recording, or by any information storage and retrieval system now known or hereafter invented, without written permission from the publisher.

Books published by Running Press are available at special discounts for bulk purchases in the United States by corporations, institutions, and other organizations. For more information, please contact the Special Markets Department at the Perseus Books Group, 2300 Chestnut Street, Suite 200, Philadelphia, PA 19103, or call (800) 810-4145, ext. 5000, or e-mail special.markets@perseusbooks.com.

ISBN 978-0-7624-5751-9

Library of Congress Control Number: 2014948505

9 8 7 6 5 4 3 2 1

Digit on the right indicates the number of this printing

Designed by www.ENVYdesign.co.uk

**Running Press Book Publishers
2300 Chestnut Street
Philadelphia, PA 19103-4371**

**Visit us on the web!
www.runningpress.com**

THE POINTLESS BOOK APP

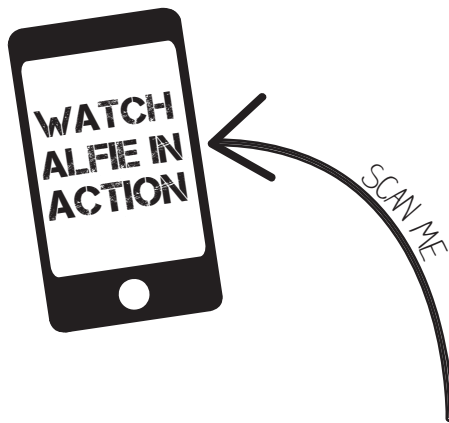

TAKE POINTLESSNESS TO ANOTHER LEVEL WITH THE POINTLESS BOOK APP WITH EXCLUSIVE VIDEOS FROM ALFIE AND MORE! ACCESS THE FREE APP FROM ITUNES OR GOOGLE PLAY, POINT YOUR DEVICE AT THE PAGES WITH THE ICON ABOVE, AND THE VIDEOS WILL BE REVEALED ON SCREEN. HERE YOU WILL GET THE CHANCE TO WATCH VIDEOS OF ALFIE MAKING A CAKE IN A MUG, PLAYING HAND SLAPS AND TAKING PART IN THE VARIOUS FUN CHALLENGES AND ACTIVITIES!

THE POINTLESS BOOK APP REQUIRES AN INTERNET CONNECTION TO BE DOWNLOADED, AND CAN BE USED ON IPHONE, IPAD OR ANDROID DEVICES. FOR DIRECT LINKS TO DOWNLOAD THE APP AND FURTHER INFORMATION, VISIT WWW.RUNNINGPRESS.COM

**COMPLETE THIS BOOK IN A
POINTLESS ORDER!**

MY JOURNAL THIS WEEK

WEEK STARTING / /

WRITE DOWN ONE SENTENCE TO DESCRIBE EACH
OF YOUR DAYS THIS WEEK.

MONDAY _____

TUESDAY _____

WEDNESDAY _____

THURSDAY _____

FRIDAY _____

SATURDAY _____

SUNDAY _____

STICK A PHOTO HERE





WRITE DOWN YOUR FAVORITE QUOTE AND WHO SAID IT



**SPRAY YOUR FAVORITE
SCENT ON THIS PAGE FOR
WHEN YOU'RE FEELING DOWN**



SMELL ME

WOULD YOU RATHER...



- 1) **Have wings or fins?**
- 2) **Have candy for dinner every day for a month or have a pint of curdled milk?**
- 3) **Have no elbows or no knees?**
- 4) **Be in a cave of spiders or snakes?**
- 5) **Swim with crocodiles or sharks?**
- 6) **Drink your own urine or eat your own puke?**
- 7) **Fight a horse-sized duck or 100 duck-sized horses?**
- 8) **Have legs as long as your fingers or fingers as long as your legs?**
- 9) **Be sexually attracted to fruit or have Cheetos dust permanently stuck to your fingers?**
- 10) **Speak any language fluently or be able to speak to animals?**

WRITE DOWN YOUR TOP FIVE CELEBRITY CRUSHES

(LOOK AT THIS LIST A MONTH FROM NOW AND SEE
IF YOU STILL AGREE!)

1.

2.

3.

4.

5.

ORIGAMI TIME!

CUT OUT THIS SQUARE AND FOLLOW THE INSTRUCTIONS ON THE NEXT PAGE





ORIGAMI TIME!

INSTRUCTIONS:

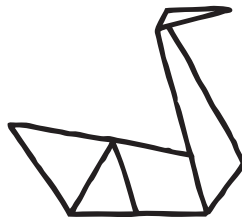
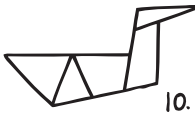
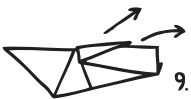
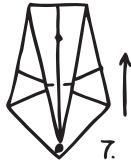
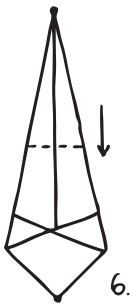
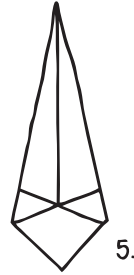
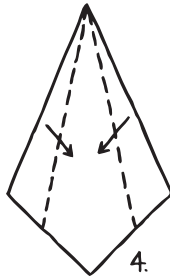
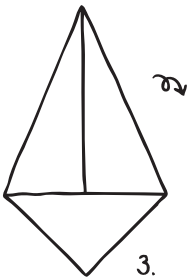
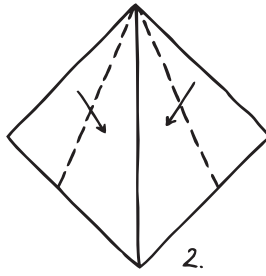
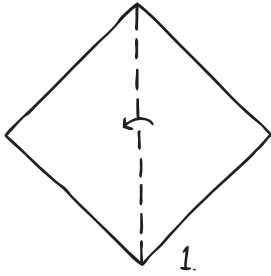

The Pointless Book 13

MAKE A PICTURE...

...WITH THE CIRCLE

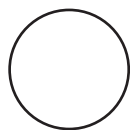

BUCKET LIST

WRITE DOWN TEN THINGS YOU'D LIKE TO DO BEFORE YOU GET OLD...

1.

2.

3.

4.

5.

6.

7.

8.

9.

10.

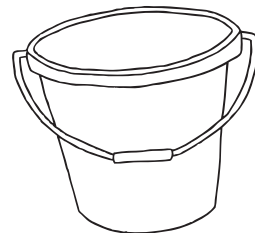



TAKE YOUR POINTLESS BOOK ON A DATE...

WHERE DID YOU GO?

WHAT DID YOU TALK ABOUT?

DID YOU KISS?



ACCENTS CHALLENGE

PLAY THE ACCENTS CHALLENGE WITH A FEW FRIENDS! DO YOUR BEST IMPRESSION OF SOMEONE TALKING IN THE FOLLOWING ACCENTS AND ASK YOUR FRIENDS TO GUESS THE COUNTRY:



AUSTRALIAN

JAMAICAN

BRITISH

FRENCH

CHINESE

SCOTTISH

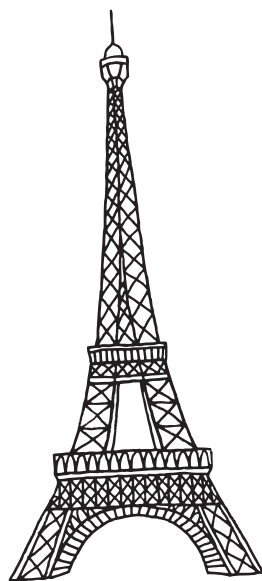

**POINTLESS
PAGE!**

WHEN YOU SEE THIS PAGE FILL IT IN WITH WHATEVER YOU WANT!

DRAW THE HAIR!

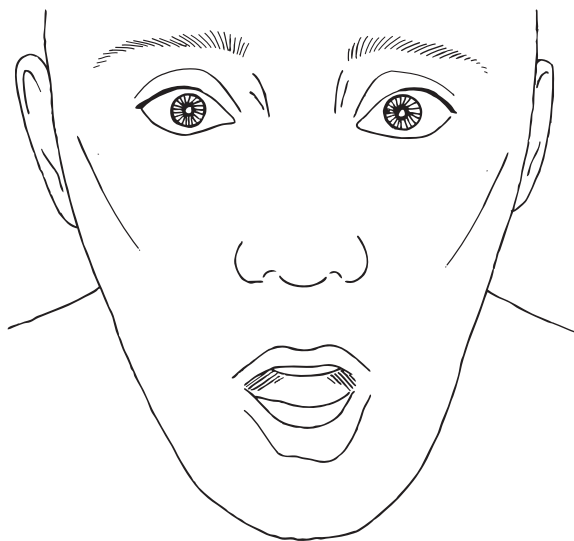

DRAW THE HAT!

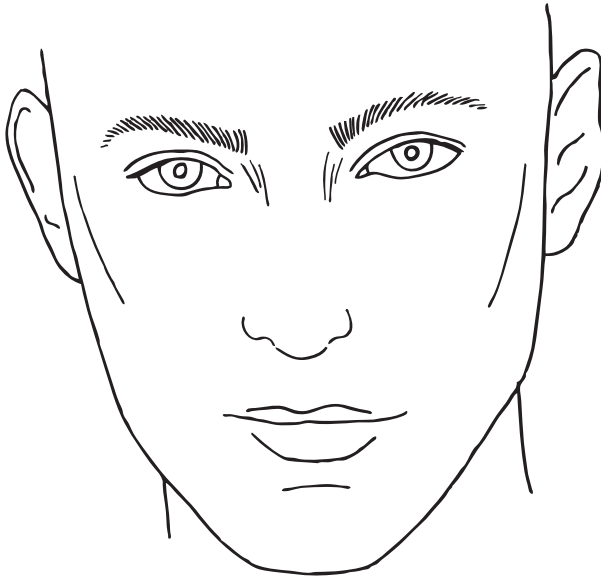

DRAW SOME MAKE UP...

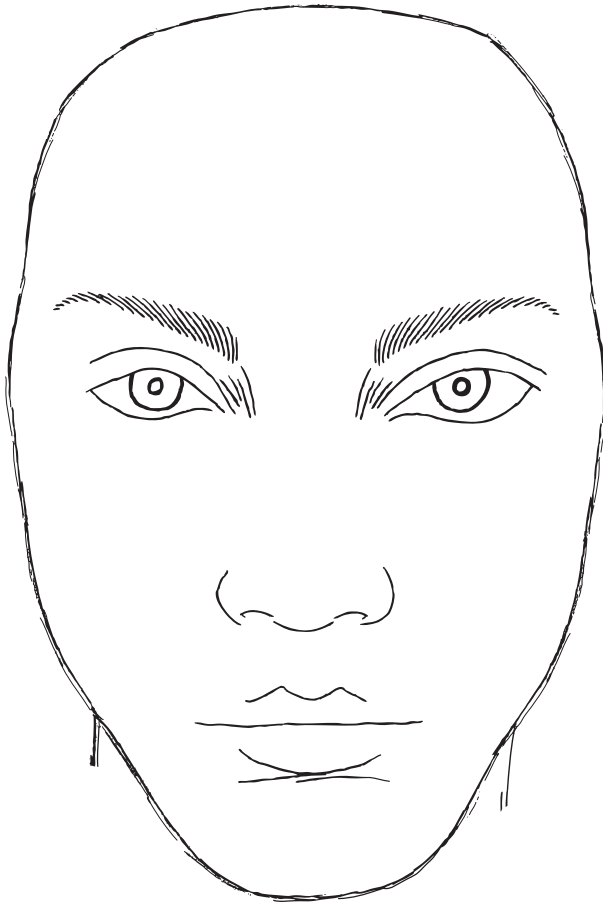

SPOT THE DIFFERENCE...

...FIVE DIFFERENCES TO FIND!





WRITE A MESSAGE FOR A FRIEND
AND SWAP PAGES WITH THEM...

TEAR HERE



TAKE A BITE OUT
OF THIS PAGE



FAVORITE EVER...

(LOOK BACK IN A MONTH AND UPDATE!)

BOOK: _____

SONG: _____

COLOR: _____

YOUTUBER: _____

FRIEND: _____

BLOGGER: _____

VIDEO GAME: _____

FILM: _____

WEBSITE: _____

EAT SOME DRY CRACKERS...

HOW MANY CAN YOU GET IN YOUR
MOUTH AT ONCE?

HOW FAST CAN YOU EAT
ONE CRACKER?

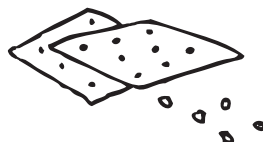

THE DICE GAME

CUT OUT THE PAPER CUBE TEMPLATE ON THE OPPOSITE PAGE, FOLD ON THE LINES AND TAPE TOGETHER TO MAKE THE DICE!

WRITE DOWN SIX THINGS THAT YOU **HAVE** TO DO IF YOU ROLL THE DICE ON THAT NUMBER. IT CAN BE A DARE, A GOOD DEED, ANYTHING, BUT YOU HAVE TO DO IT!

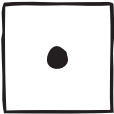







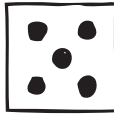

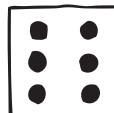

CUT OUT THE DICE TEMPLATE
(JUST THE OUTLINE)

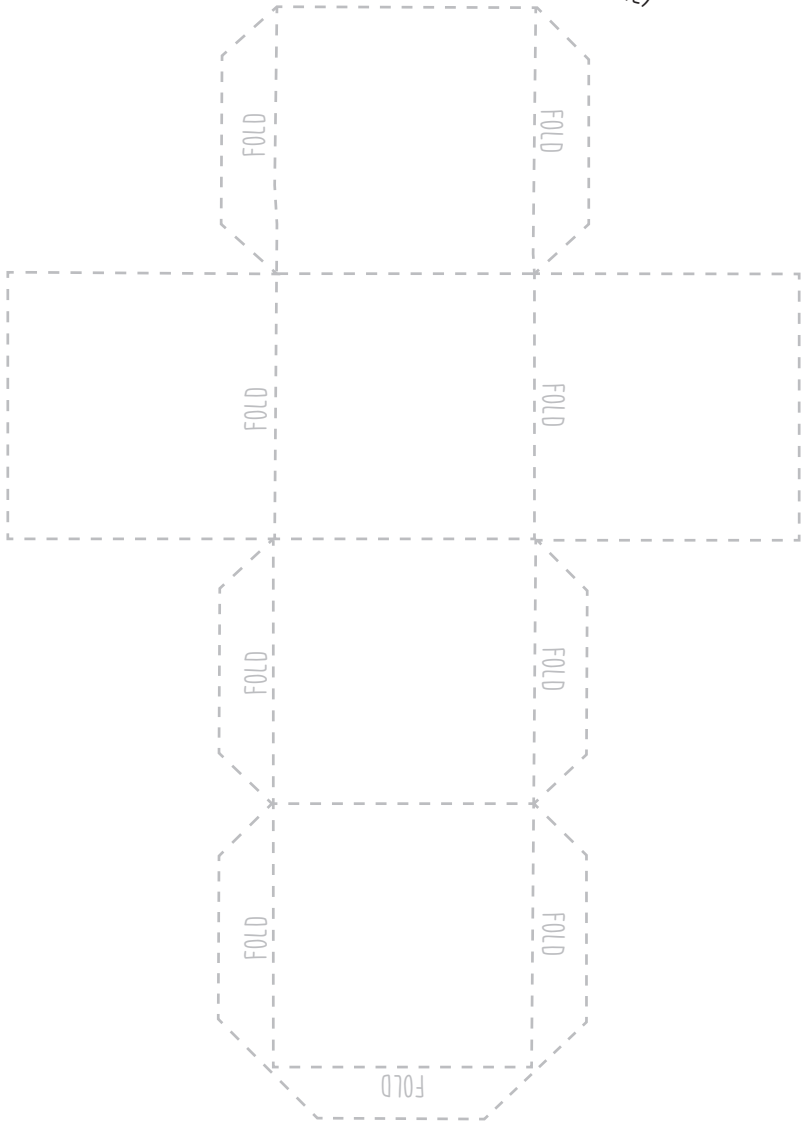

(YOU WILL NEED STICKY TAPE!)

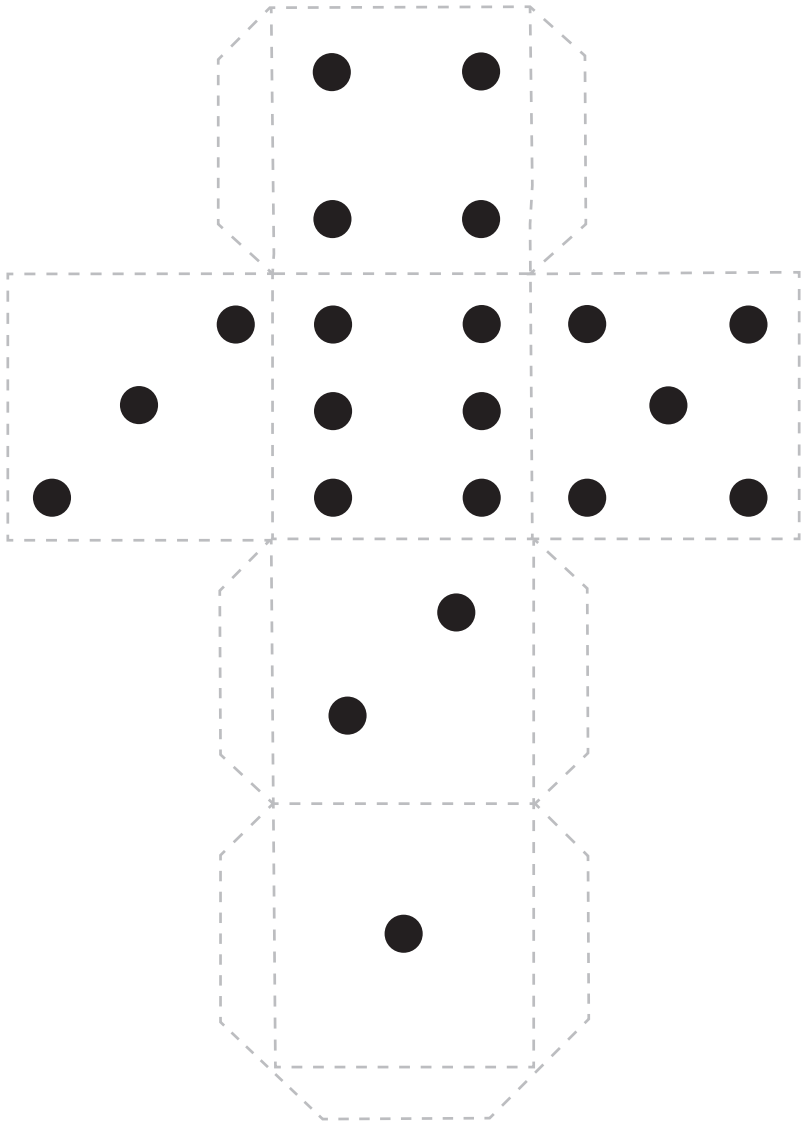

PLAY HAND-SLAPS



KEEP SCORE HERE:

PLAYER 1	PLAYER 2

WINNER: _____

DESIGN A TATTOO

DRAW A TATTOO YOU'D LOVE TO GET IN THE FUTURE

STAPLE THIS PAGE

CREATE SOME ART
#THEPOINTLESSBOOK
WITH YOUR DESIGN

The Pointless Book 35



PEOPLE-WATCHING PAGE...

TICK WHEN YOU SEE:

- A MAN WITH A BEARD
- A LADY WITH RED HAIR
- SOMEONE WEARING A CAST
- A CHILD WITH A PACIFIER
- A YELLOW CAR
- SOMEONE TAKING A SELFIE
- A MAILMAN

DRAW THESE SHAPES...

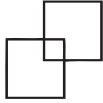

...WITHOUT TAKING YOUR
PEN OFF THE PAPER

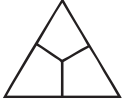
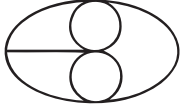

CONSEQUENCES...

FOLD HERE

...INSTRUCTIONS OVERLEAF

The Pointless Book 39

CONSEQUENCES...

PLAY WITH A FRIEND!

1. WRITE DOWN A GIRL'S NAME, FOLD IT OVER AND HAND TO THE NEXT PLAYER.
2. WRITE A BOY'S NAME, FOLD IT OVER AND PASS ON AGAIN.
3. WRITE WHERE THEY MET, FOLD OVER AND PASS ON.
4. WRITE WHAT SHE SAID TO HIM, FOLD OVER AND PASS ON.
5. WRITE WHAT HE SAID TO HER.
6. CONSEQUENCE... YOU DECIDE THE ENDING.
7. UNRAVEL THE STORY AND READ BACK!

**WRITE DOWN YOUR FIVE
FAVORITE THINGS ABOUT
YOURSELF AND WHY...**

1.

2.

3.

4.

5.

**PASS YOUR BOOK TO A
STRANGER AND ASK THEM TO
DRAW A PICTURE OF YOU..**

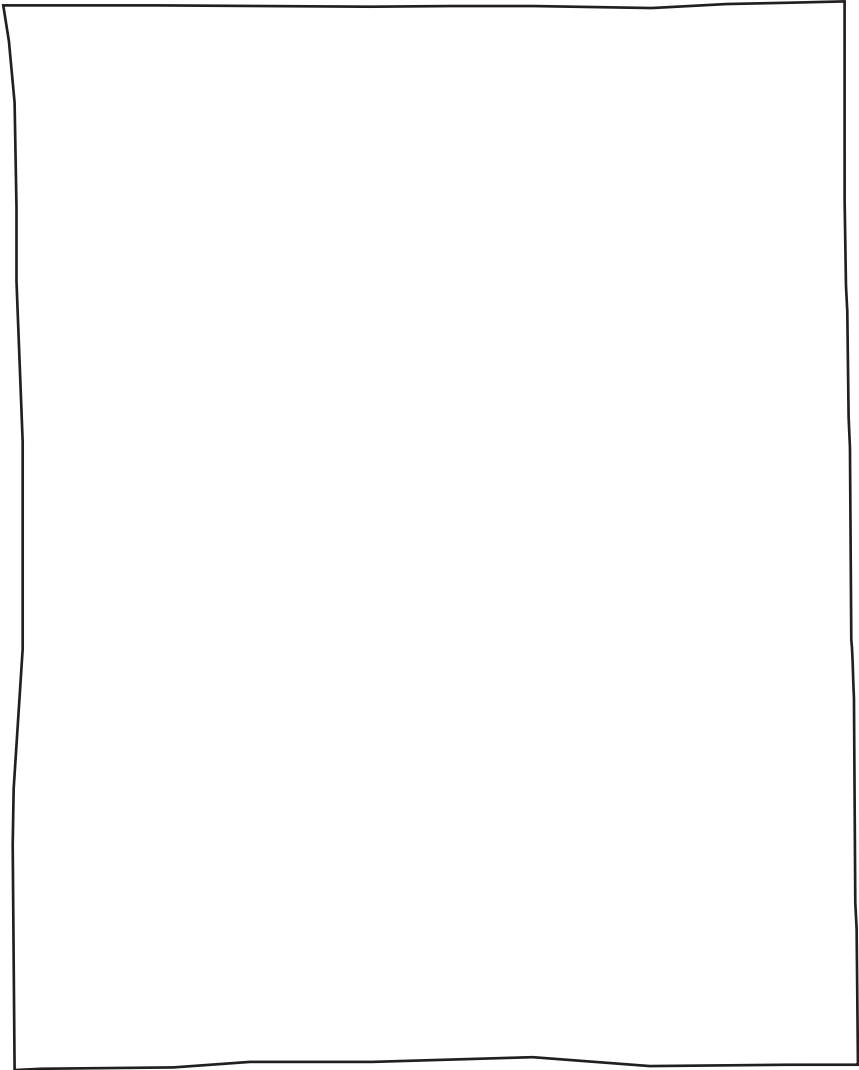

WORD SEARCH!



YOUTUBE
VLOGGER
POINTLESS BOOK

SMILE
BRIGHTON
TRAVEL

COFFEE
INTERNET
CHICKEN WINGS

**TRACE THE OUTLINE OF YOUR
FAVORITE FOOD ON THIS PAGE...**

CONCERTINA STORY

WRITE A COUPLE OF LINES OF A STORY, FOLD BACK THE PAGE FOR A FRIEND TO
WRITE THE NEXT LINE AND SO ON... OPEN UP TO REVEAL A HILARIOUS STORY

FOLD HERE

...IRON THE CREASES OUT OF THIS PAGE.

**PLAY A SONG AND WRITE THE
LYRICS ON THIS PAGE...**



DRAW CLOTHES ON THE PEOPLE BELOW...

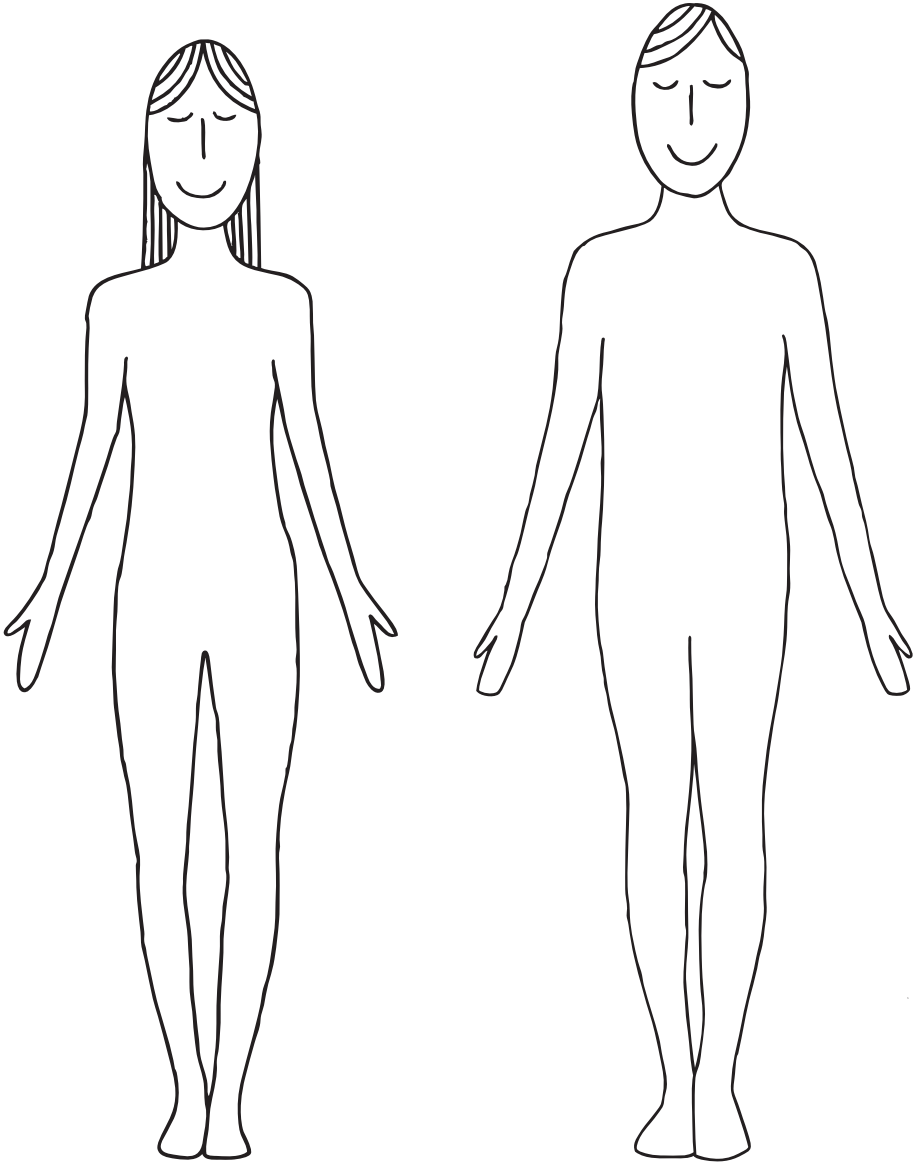

**WRITE A COMPLIMENT ON
THIS PAGE, RIP IT OUT
AND PASS IT TO A FRIEND**



TAKE A PHOTO OF YOURSELF HOLDING YOUR
BOOK IN THE CRAZIEST PLACE YOU CAN
THINK OF AND UPLOAD IT USING

#PBONTOUR

**MAKE THIS PAGE AS
MESSY AS YOU CAN**

ALFIE'S CAKE IN A MUG RECIPE...



INGREDIENTS

4 TBSP SELF-RISING FLOUR
2 TBSP COCOA POWDER
4 TBSP SUGAR
3 TBSP MILK
1 MEDIUM EGG

3 TBSP VEGETABLE/
SUNFLOWER OIL

A FEW DROPS VANILLA
EXTRACT (IF YOU'RE
FEELING FANCY)

2 TBSP CHOCOLATE CHIPS

METHOD

FIND A MUG. MAKE SURE IT'S A BIG ONE OTHERWISE IT'LL OVERFLOW IN THE MICROWAVE. PLUS WE ALL LIKE A BIG CAKE

ADD THE FLOUR, COCOA POWDER AND SUGAR TO THE MUG AND MIX INTO A CHOCOLATY PASTE. ADD THE EGG AND GIVE IT A GOOD MIX; THEN ADD EVERYTHING ELSE — SO THE MILK, VEGETABLE OIL AND THE VANILLA ESSENCE — BUT NOT THE CHOCOLATE CHIPS! ONCE YOU HAVE EVERYTHING IN THE MUG AND IT'S LOOKING SMOOTH AND DELICIOUS, ADD THE CHOCOLATE CHIPS.

PLACE YOUR LOVELY MUG IN THE MIDDLE OF THE MICROWAVE AND COOK ON THE HIGHEST SETTING FOR 4-5 MINUTES. KEEP AN EYE ON IT THROUGH THE WINDOW AS IT MIGHT OVERFLOW.

WAIT FOR THE 'DING'. TAKE THE MUG OUT, LET IT COOL THEN SIT DOWN AND EAT!

REMEMBER
TO DRINK
LOTS OF
WATER
TODAY.
STAY
HYDRATED
:)

WRITE WHATEVER'S ON YOUR MIND

...WITHOUT STOPPING UNTIL YOU GET TO THE END OF THE PAGE





**DRAW YOUR OWN
TIME MACHINE**

DRAW WHERE YOU'D LIKE TO GO—TO THE PAST OR THE FUTURE?



The Pointless Book 57

POINTLESS PAGE!

WHEN YOU SEE THIS PAGE FILL IT IN WITH WHATEVER YOU WANT!

A TEAR-OFF LETTER

WRITE SOMEONE YOU KNOW A LETTER ON THIS
PIECE OF PAPER, TEAR IT OFF AND SEND IT TO THEM

TEAR HERE

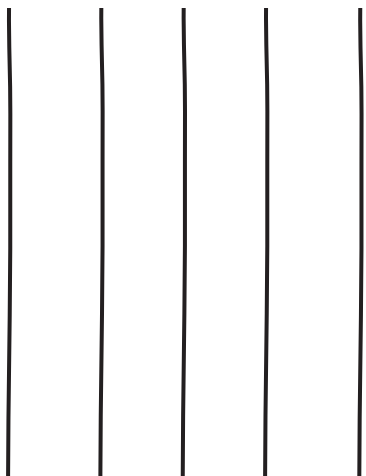

DOT TO DOT!

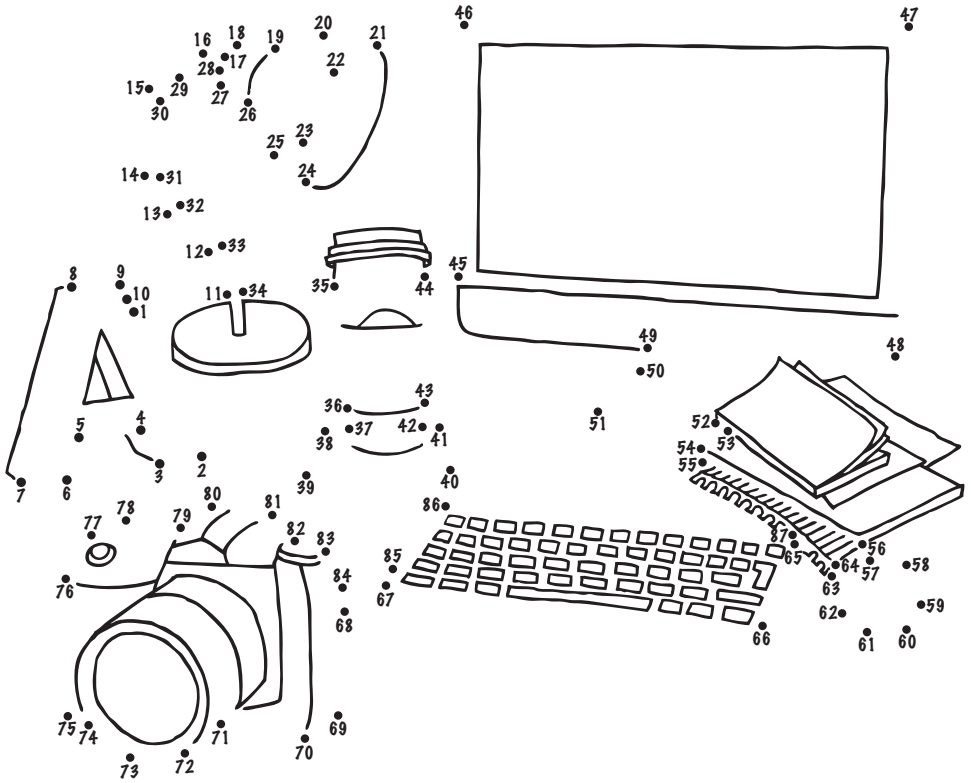

BURY THIS BOOK UNDERGROUND

(FOR ONE NIGHT, DIG IT UP AND SIGN THIS PAGE ONCE YOU'VE DONE SO.)

DATE:

SIGN HERE:

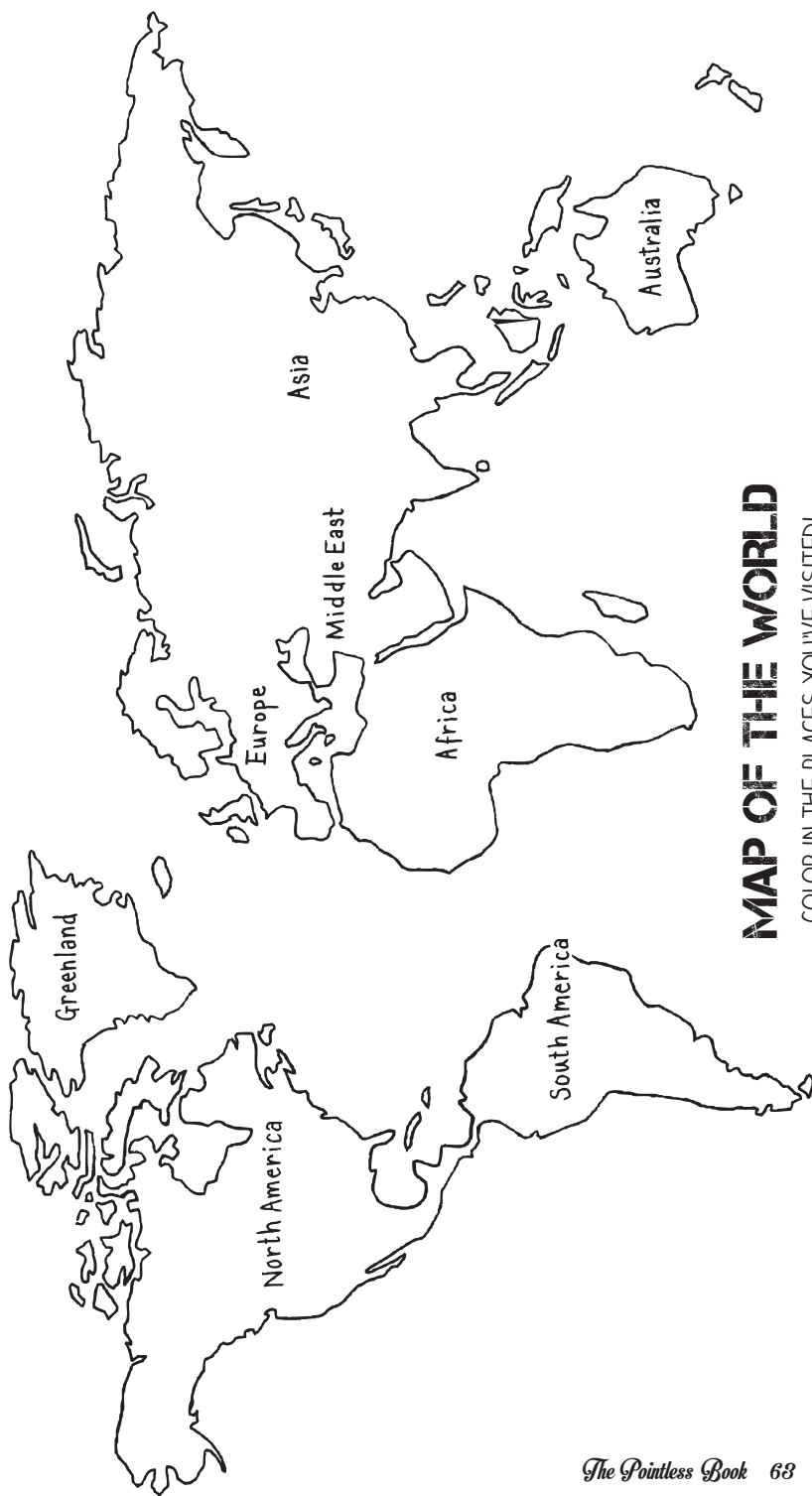

MAP OF THE WORLD

COLOR IN THE PLACES YOU'VE VISITED!

MY LIFE AMBITIONS...

IN MY LIFE I WOULD LIKE TO...

1.

2.

3.

4.

5.

6.

PAPER AIRPLANE COMPETITION

RIP OUT THIS PAGE AND MAKE A PAPER AIRPLANE.

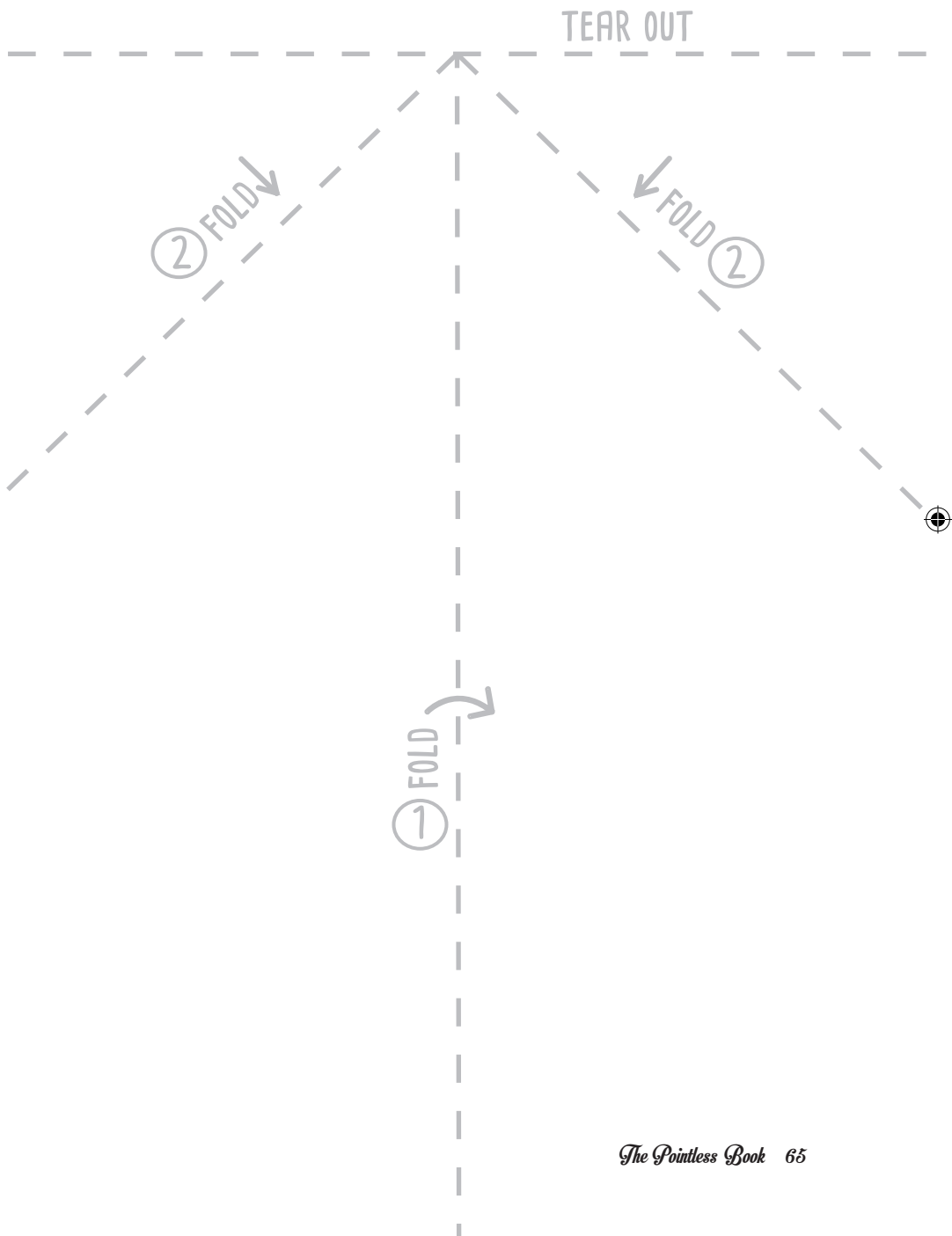



TEAR OUT

FOLD 3

FOLD 3

FOLD 5

FOLD 5

FOLD 4

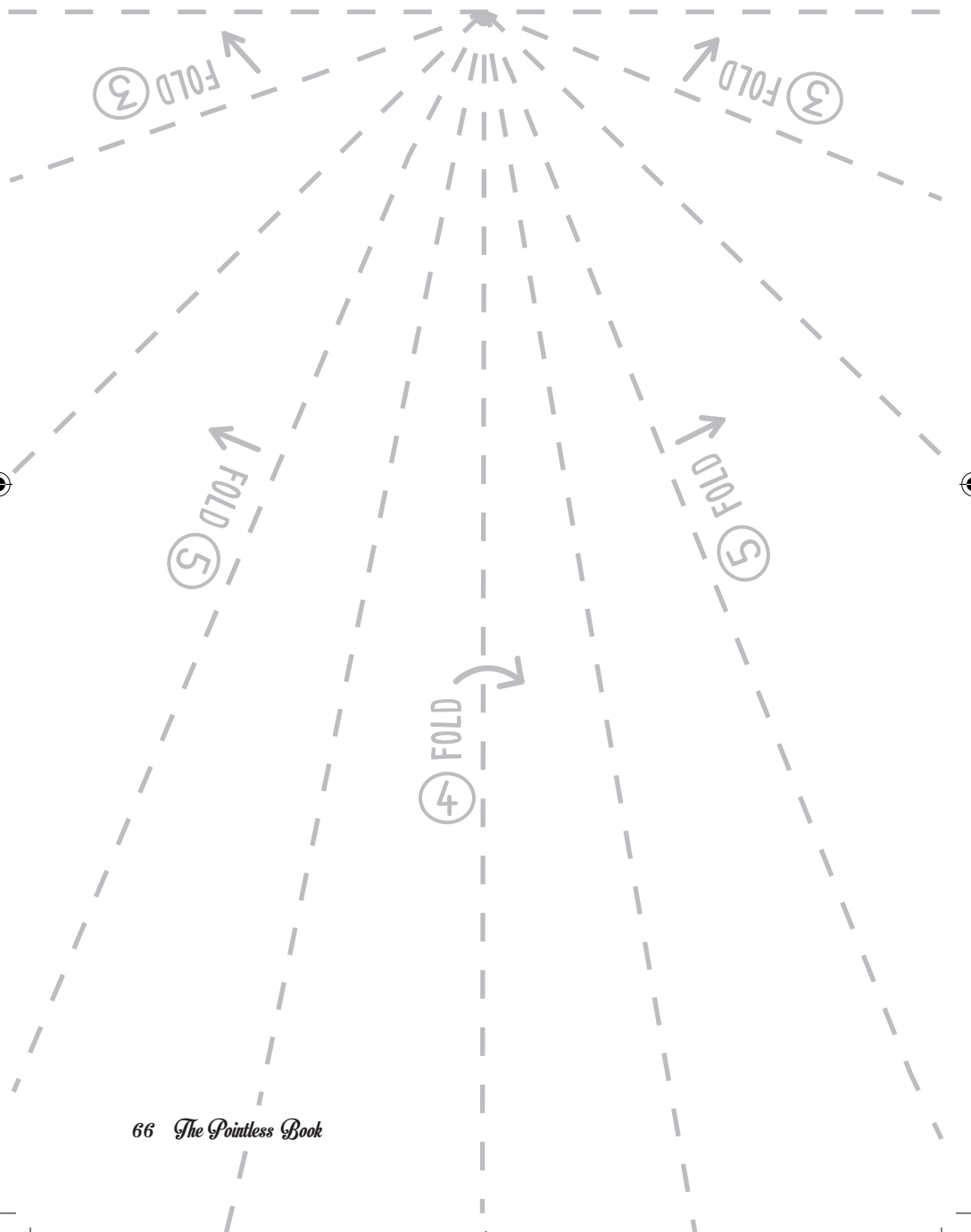

FIVE YOGA POSITIONS TO LEARN...

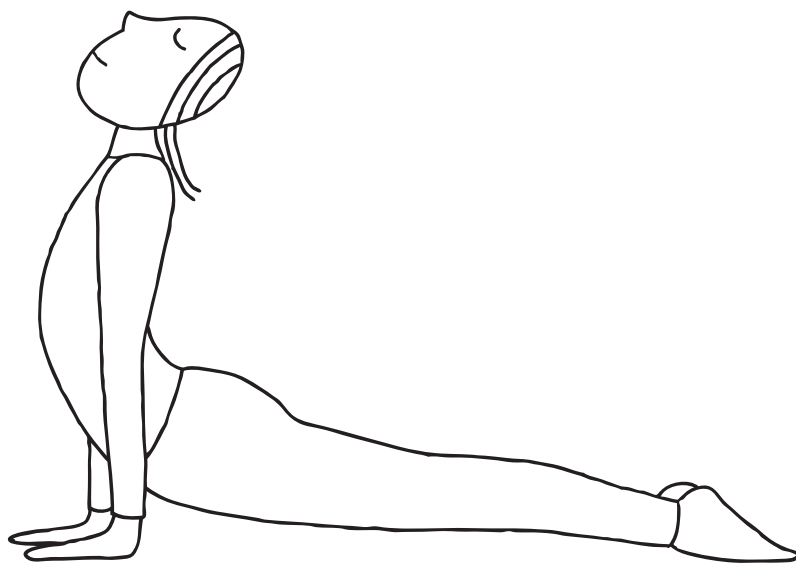

COBRA

FIVE YOGA POSITIONS TO LEARN...

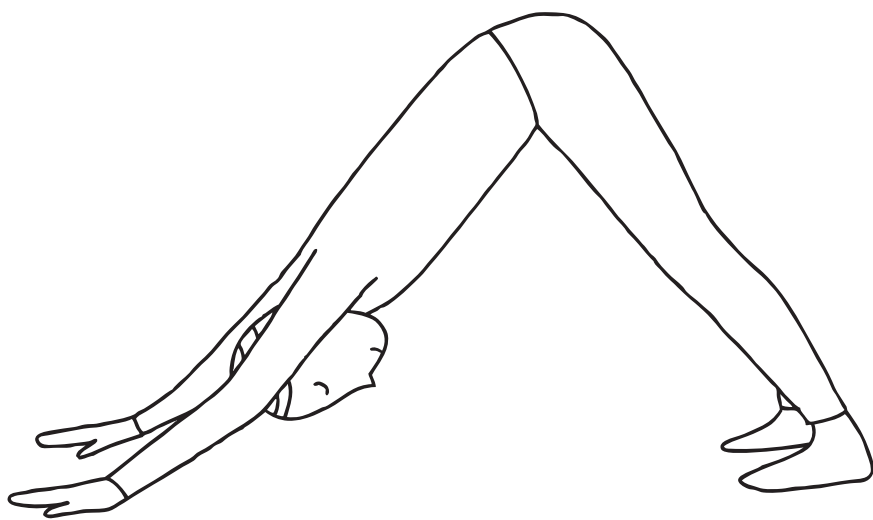

DOWNWARD-FACING DOG

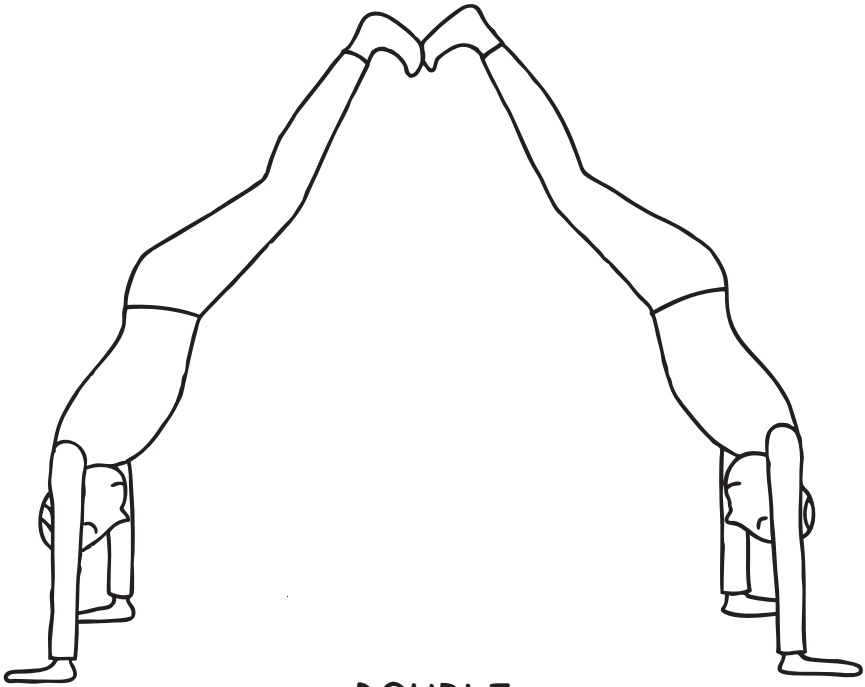

DOUBLE
HANDSTAND

FIVE YOGA POSITIONS TO LEARN...

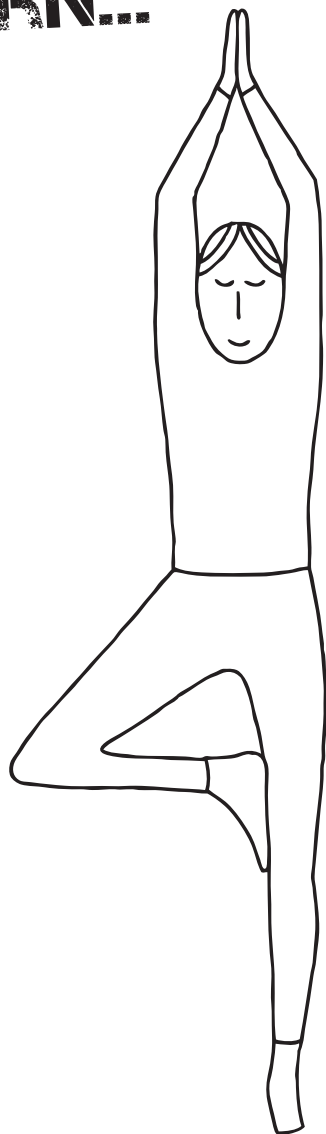

TREE

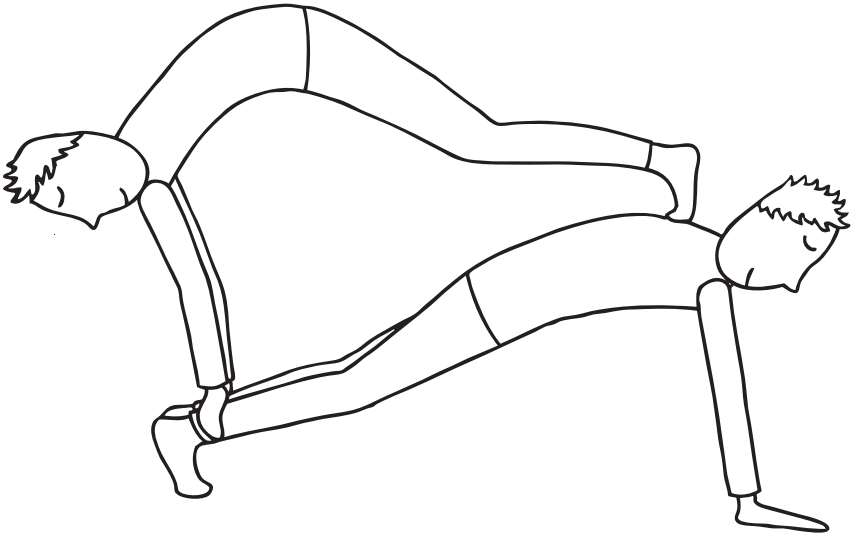

DOUBLE
TRIANGLE



GO TO PAGE **97**

MESSAGE IN A BOOK...

WRITE A MESSAGE ON THIS PAGE, RIP IT OUT AND SNEAK IT INTO SOMEONE ELSE'S BOOK!

TEAR HERE

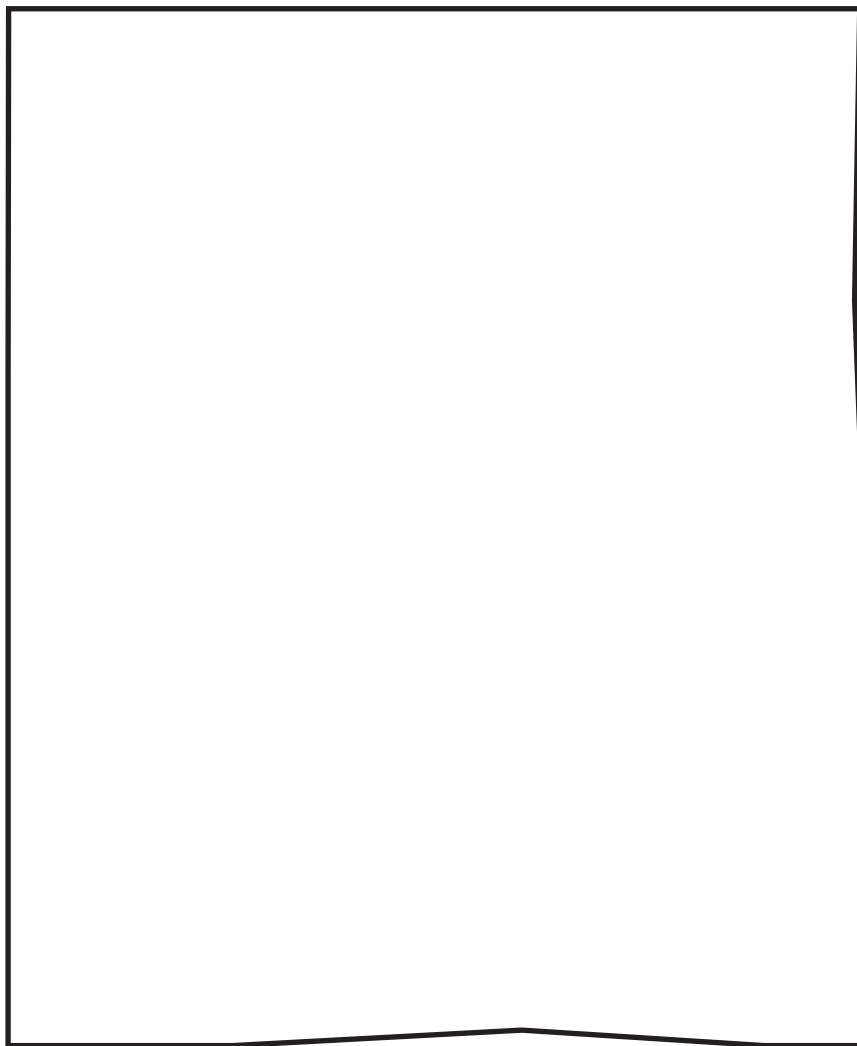

IF YOU'RE LUCKY ENOUGH TO FIND THIS PAGE TWEET
#THEPOINTLESSBOOK

The Pointless Book 73

#THEPOINTLESSBOOK

DRAW A FINGER SELFIE..



PLACE A FINGER IN ONE OF THE SPACES BELOW AND DRAW A FACE, A BEARD, A CRAZY MOUSTACHE, WHATEVER YOU LIKE AND THERE YOU GO — YOU HAVE A FINGER SELFIE! SHARE YOUR FINGER SELFIES BY POSTING WITH #PBFINGERSELFE

PLACES I'D LIKE TO TRAVEL TO...



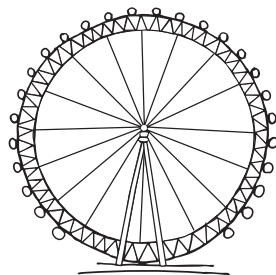

PLAY SQUARES...

...WITH A FRIEND. TAKE TURNS MAKING A LINE JOINING TWO DOTS BUT TRY TO PREVENT THE OTHER PLAYER FROM MAKING A SQUARE. FILL THE DOTS WITH SQUARES AND THE PERSON WITH THE MOST WINS!

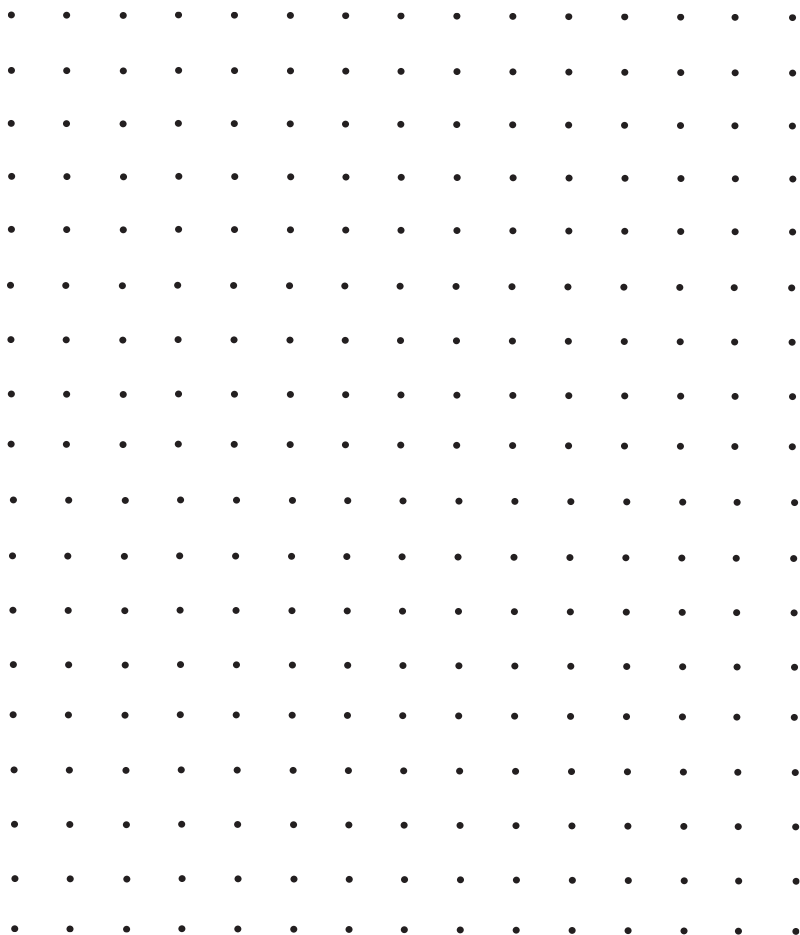



MY FAVORITE CHILDHOOD MEMORY IS...





GRAFFITI THIS WALL



TURN THIS PAGE WITH YOUR ELBOW 



**WHAT IS THE LAST THING
YOU DO BEFORE YOU FALL
ASLEEP AND WHY?**



TURN THIS PAGE WITH YOUR EAR

FLICK SOME PAINT ON THIS PAGE

BASKETBALL CHALLENGE

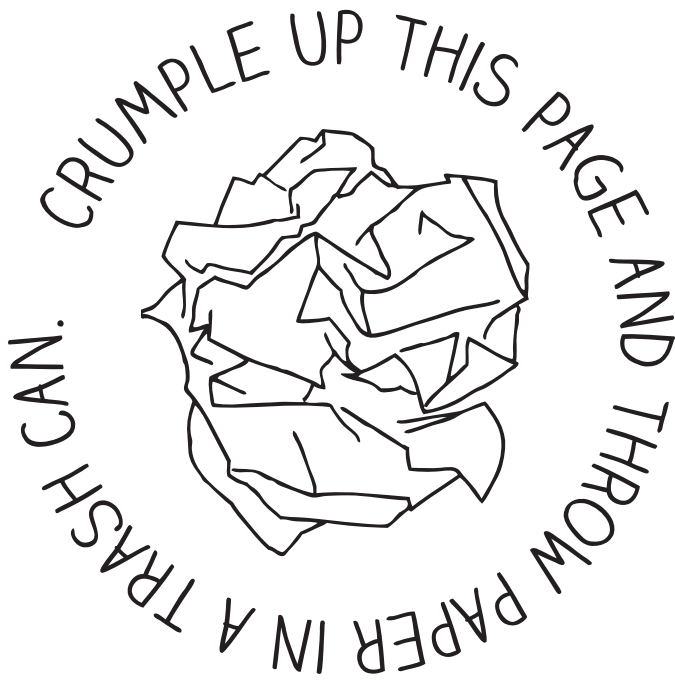



FINISH OFF THE PICTURE...

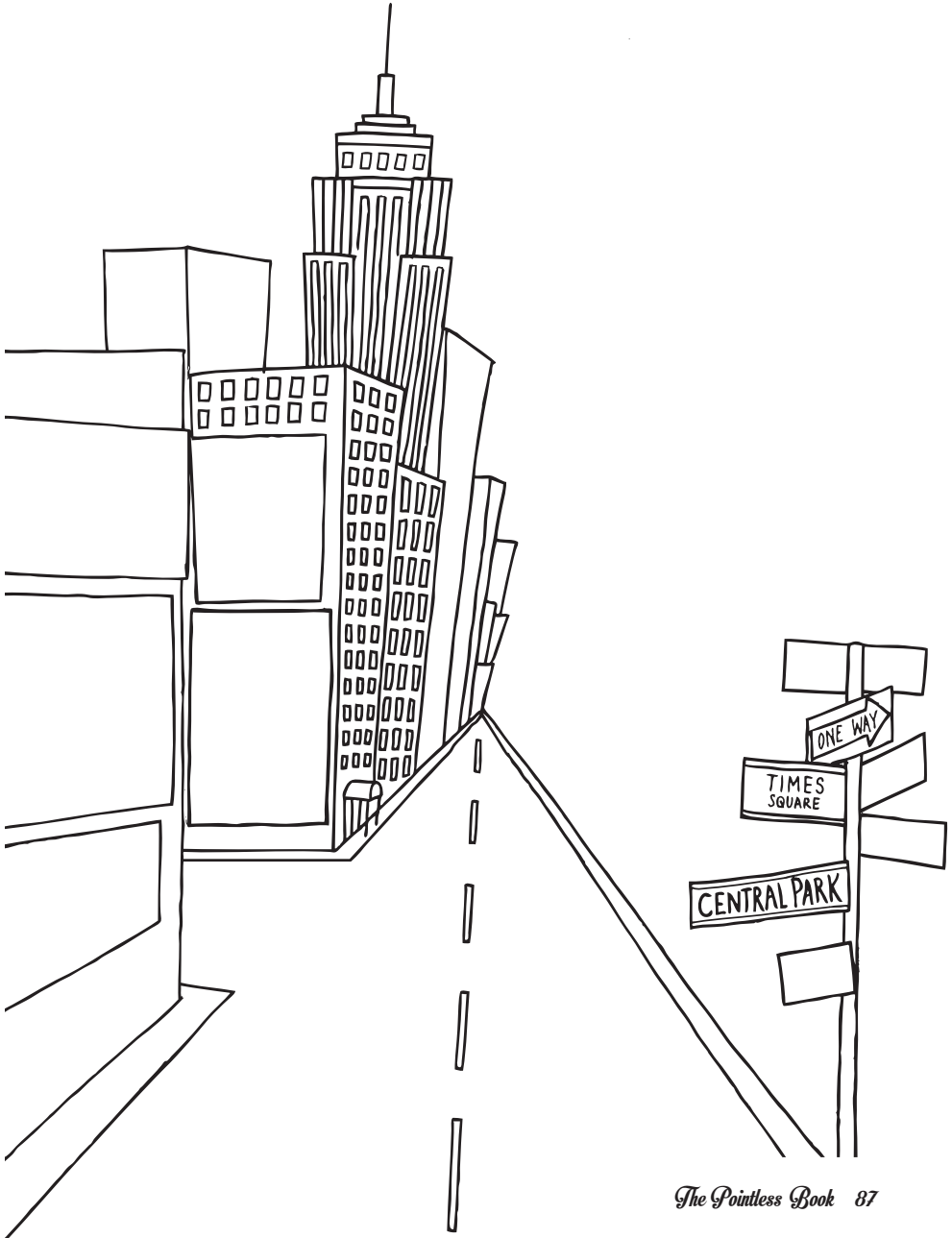

NOT TO DO LIST...

WRITE DOWN FIVE THINGS YOU'D LIKE TO AVOID DOING TODAY:

1.

2.

3.

4.

5.

WRITE DOWN A SECRET...



ROAD TRIP!

FIRST ONE TO SEE A:...

RED CAR

GAS STATION

CROW

TIRE ON THE SIDE OF THE ROAD

GIRL WITH BLONDE HAIR

GUY WEARING A BLUE T-SHIRT

HITCHHIKER

SEAGULL

ROAD KILL

FOOD TRUCK

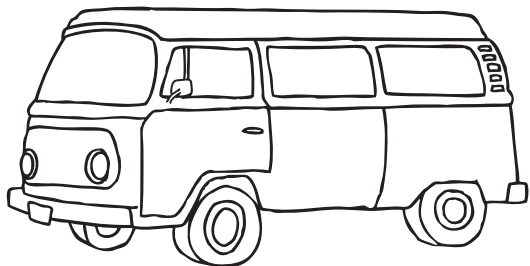

THE HEADBAND CHALLENGE

RIP OUT AND WRITE DOWN THE NAME OF A FAMOUS PERSON ON THE STRIPS BELOW. YOU AND A FRIEND LICK AND STICK IT ON YOUR HEAD (DON'T LOOK!) AND EACH PERSON ASKS A 'YES' OR 'NO' QUESTION IN ORDER TO GUESS WHO THEIR PERSON IS.

TEAR HERE

TEAR HERE

TEAR HERE

TEAR HERE

TEAR HERE

TEAR HERE

TEAR HERE

**DO SOMETHING YOU'VE NEVER
DONE BEFORE AND WRITE IT DOWN
HERE.**

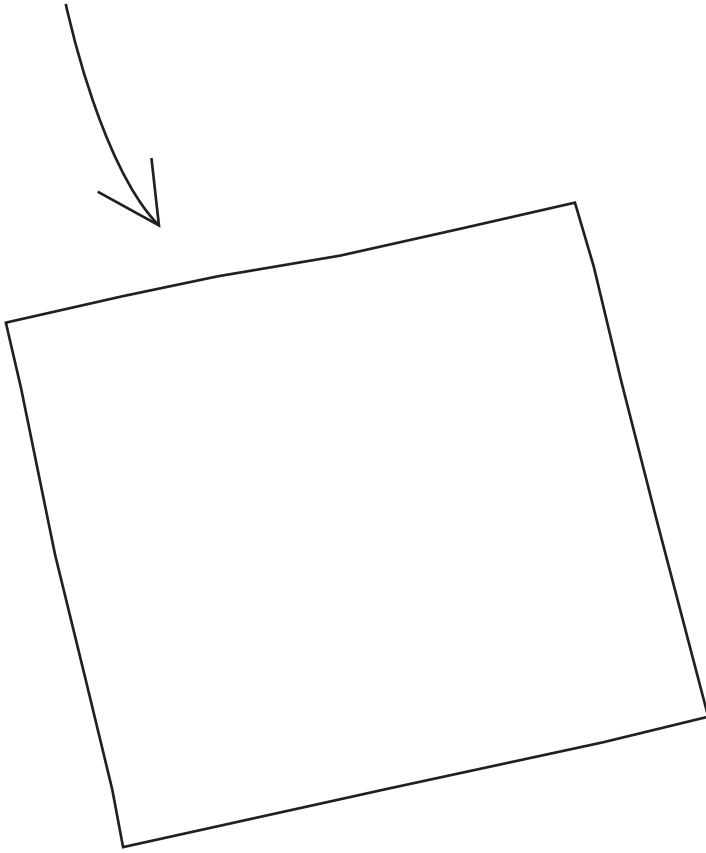

DRAW YOUR DAY IN A STORYBOARD

WRITE HERE

DRAW HERE

DATE: / /

PASS THIS BOOK...

...WITH A GROUP OF FRIENDS
PASS THE BOOK UNDER YOUR
CHIN, WHOEVER DROPS IT IS OUT!

CHALLENGE TIME

OK, LET'S SEE HOW LONG YOU CAN BE SILENT FOR...

ATTEMPT 1: _____

ATTEMPT 2: _____

ATTEMPT 3: _____

ATTEMPT 4: _____

ATTEMPT 5: _____

PERSONAL BEST: _____



PRESS SOME FLOWERS...

...BETWEEN THESE PAGES



The Pointless Book 99

**PAINT A PICTURE USING PAINT AND
ONLY YOUR FINGERS...**



100 *The Pointless Book*

LOVE LETTER...

...TEAR THIS PAGE OUT AND WRITE SOMEONE A
LOVE LETTER

TEAR HERE

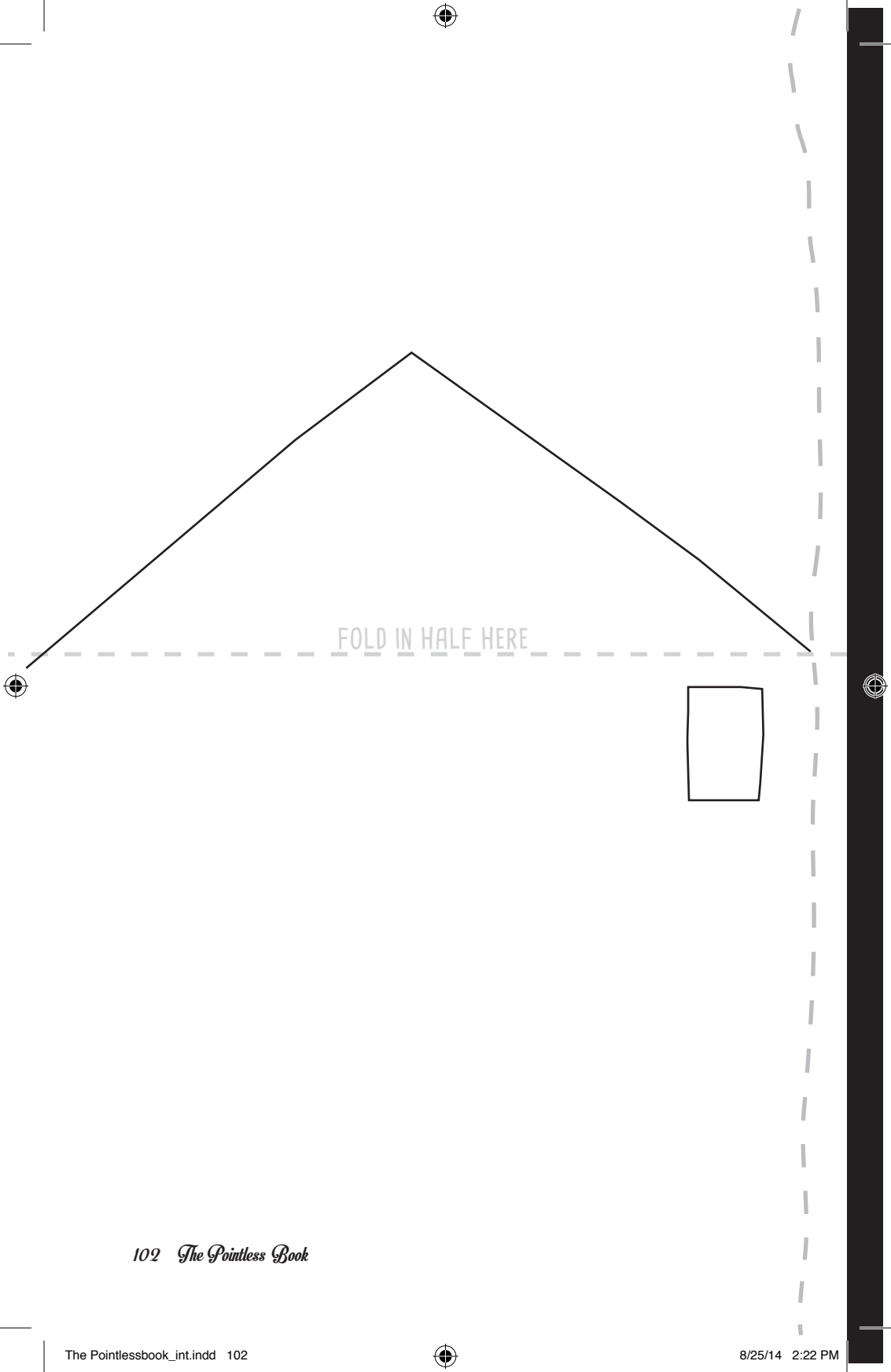

FOLD IN HALF HERE

PHONE BINGO!

PLAY PHONE BINGO WITH A FRIEND (OR GROUP OF FRIENDS). CALL A RANDOM PERSON IN YOUR CONTACTS AND EACH PLAYER HAS TO GET THE SELECTED LIST OF WORDS BELOW INTO THE CONVERSATION, CROSS THEM OFF, THEN SHOUT 'PHONE BINGO!'

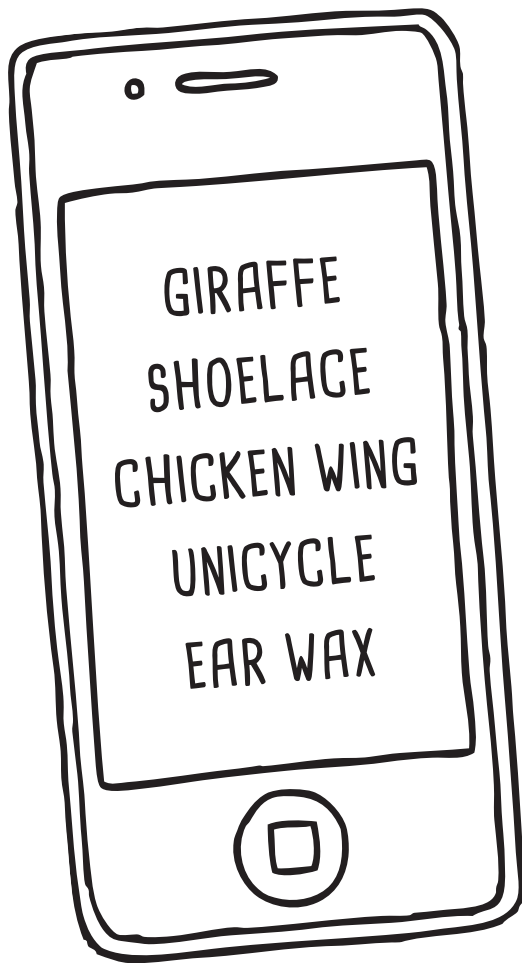



**USE YOUR OLD NAIL POLISH
TO PAINT THIS PAGE**



POINTLESS PAGE!

WHEN YOU SEE THIS PAGE FILL IT IN WITH WHATEVER YOU WANT!



Os 'N' Xs

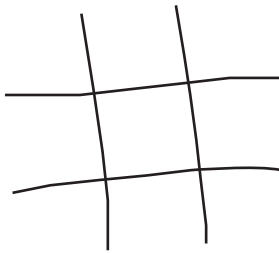
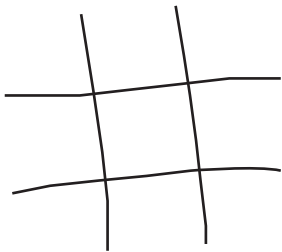
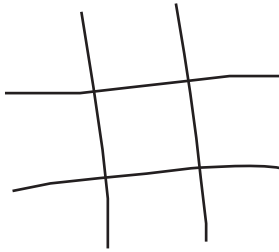
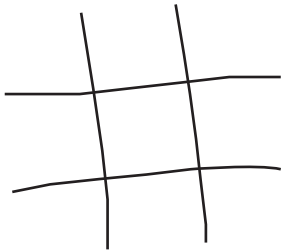
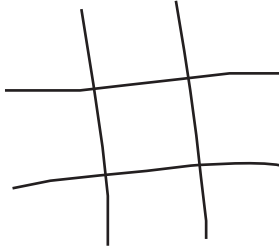
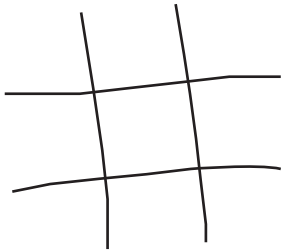

MUSIC MAKER!

WRITE A SELECTION OF LYRICS FROM YOUR TOP FIVE FAVORITE SONGS AND MAKE UP A NEW SONG:

HEAD, BODY AND TAILS

WITH A GROUP OF FRIENDS, TAKE IT IN TURN TO DRAW THE PARTS OF A PERSON ON THE PAGE BELOW. BEGIN WITH THE HEAD, FOLD THE PAGE AND PASS TO WHOEVER IS ON YOUR RIGHT. ONCE YOU'VE COMPLETED THE HEAD, SHOULDERS, BODY, LEGS AND FEET, OPEN IT UP TO REVEAL YOUR CREATION!

HEAD



SHOULDERS



BODY



LEGS



FEET



TEAR HERE



ANAGRAM PAGE!

UN-SCRAMBLE THE FOLLOWING POINTLESS ANAGRAMS:

GOBLIN TOPLESS

EARN DUVET

MIMES MUTER

HAT PAY SPY

HAPPY HOG ROT

WRITE A POEM..

BRAIN TEASERS...

TRY YOUR BEST TO SOLVE THESE:

WHAT
TRAVELS
AROUND THE WORLD
BUT STAYS IN THE
CORNER?

WHAT GETS
WETTER AND
WETTER THE MORE
IT DRIES?

WHAT CAN
YOU CATCH
BUT CAN'T
THROW?

WHICH WORD IN
THE DICTIONARY
IS SPELLED
INCORRECTLY?

YOU CAN
HOLD IT WITHOUT
USING YOUR
ARMS. WHAT IS
IT?

NOTES

USE THIS PAGE WHEN YOU NEED SOME PAPER!

POINTLESS PAGE!

WHEN YOU SEE THIS PAGE FILL IT IN WITH WHATEVER YOU WANT!

TURN TO PAGE 15



DESIGN YOUR OWN ALBUM COVER

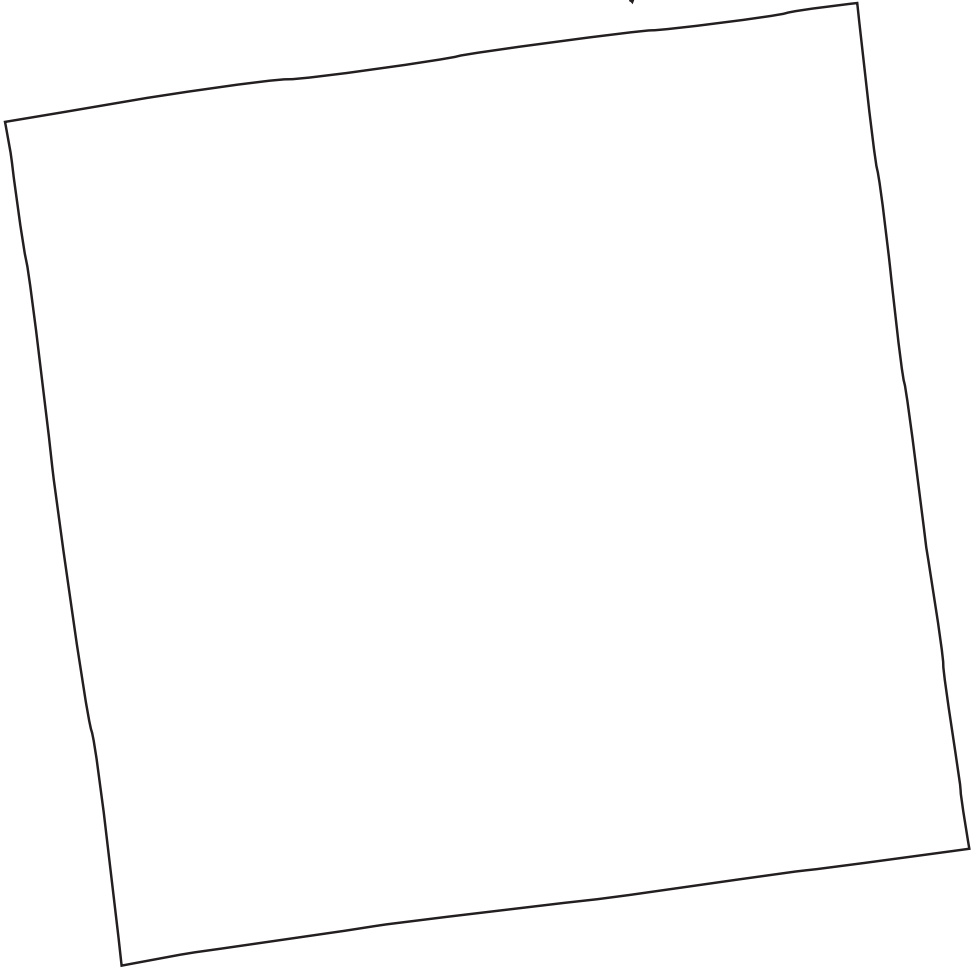

MY JOURNAL THIS WEEK

WEEK STARTING / /

WRITE DOWN ONE SENTENCE TO DESCRIBE EACH
DAY THIS WEEK.

MONDAY _____

TUESDAY _____

WEDNESDAY _____

THURSDAY _____

FRIDAY _____

SATURDAY _____

SUNDAY _____

CONSEQUENCES...

GAME 1:

(SEE RULES ON PAGE 40)

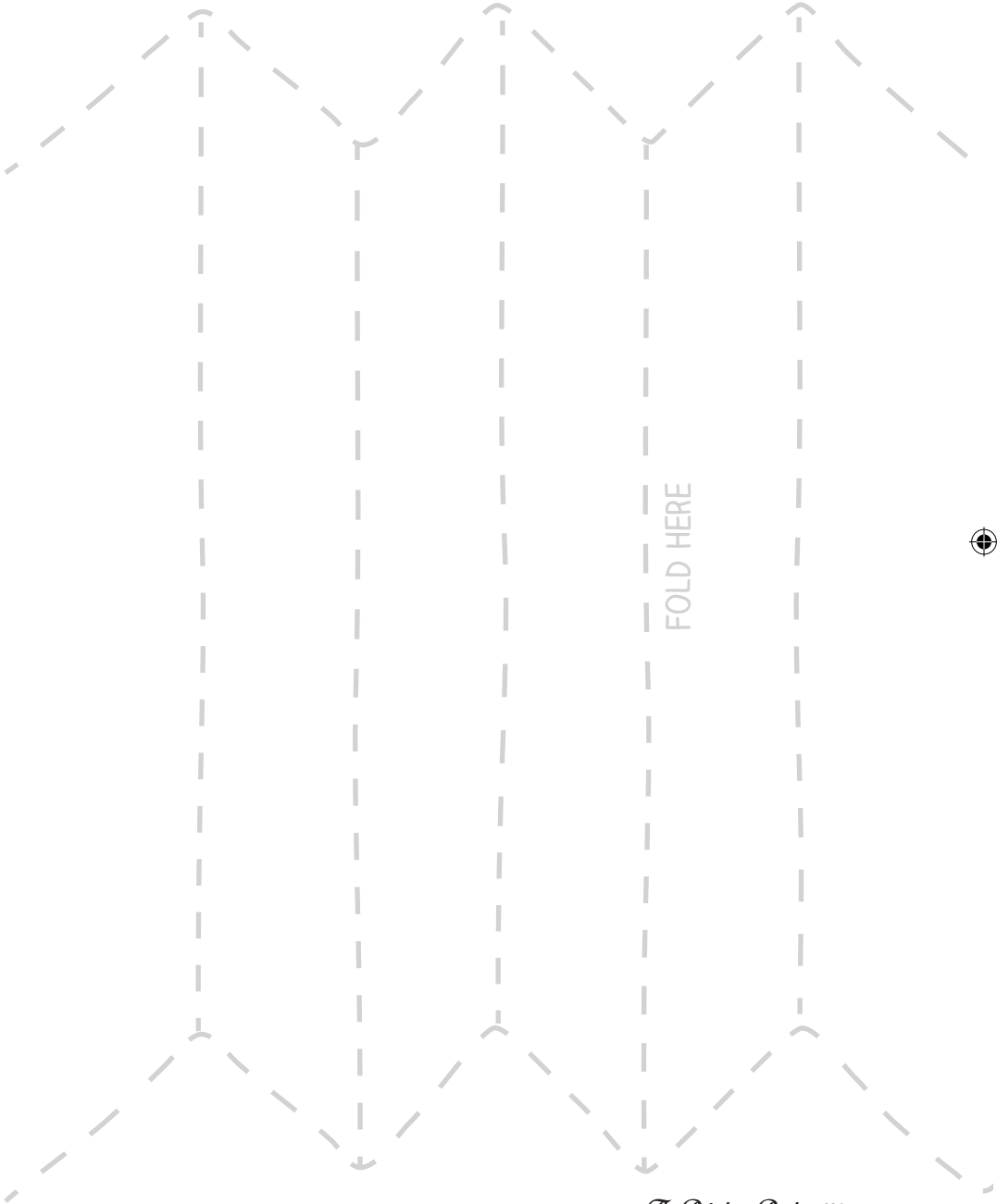

The Pointless Book 119

GAME 2:

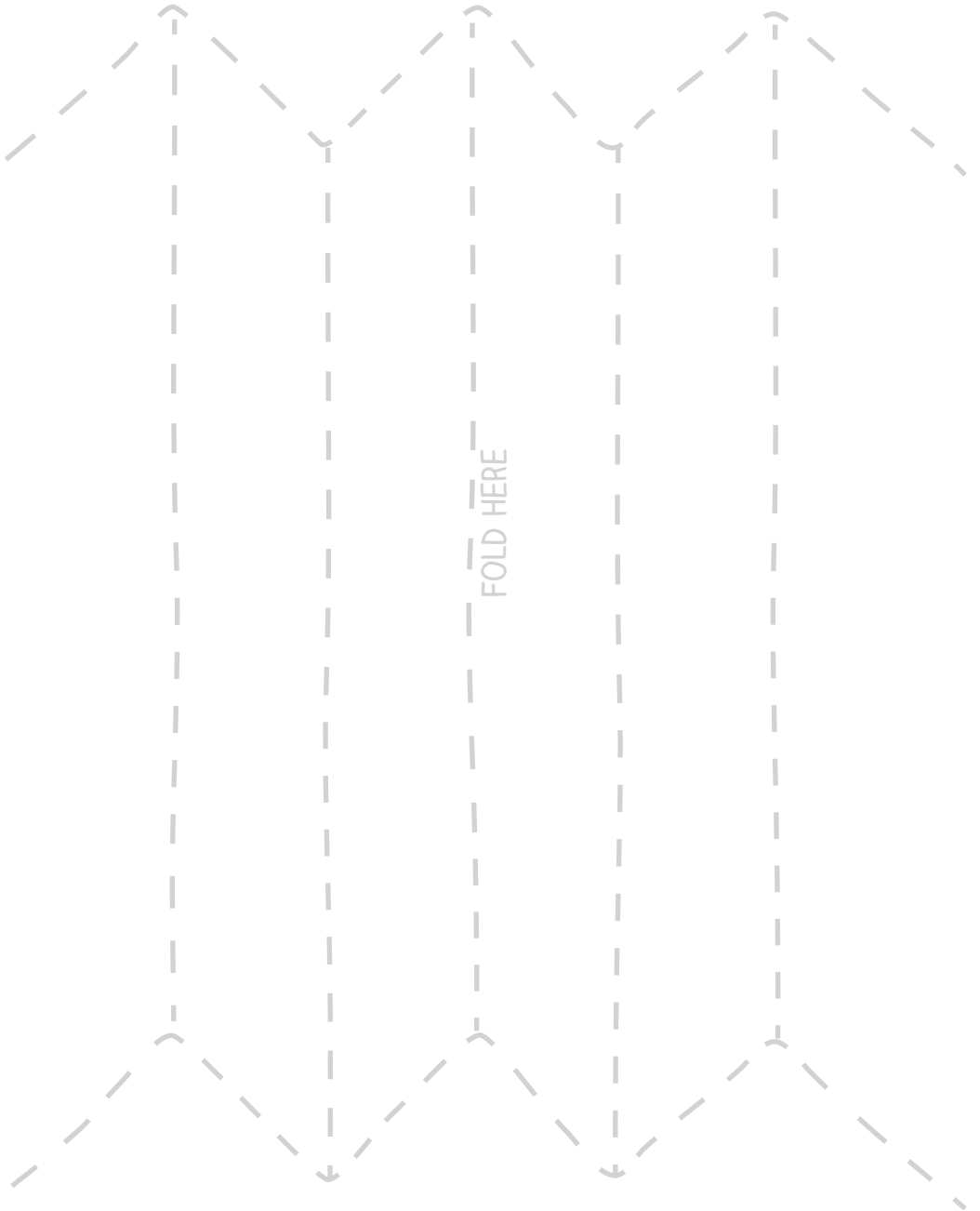

TEAR THE CORNERS OFF THIS PAGE

404 PAGE NOT FOUND

**HOLE-PUNCH
THIS PAGE!**

CREATE SOME ART USING A HOLE-PUNCH!

ROCK, PAPER, SCISSORS

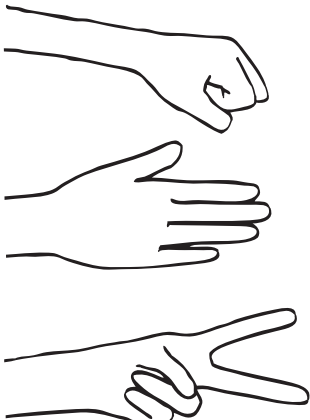

KEEP SCORE HERE:

PLAYER 1	PLAYER 2
	<p>WINNER:</p>

**DRAW AROUND YOUR
OWN HAND...**

THUMB WARS

KEEP SCORE HERE:

PLAYER 1	PLAYER 2

WINNER: _____

PEOPLE WATCHING PAGE...

TICK WHEN YOU SEE:

- SOMEONE WEARING FLIP-FLOPS

- SOMEONE RIDING A SKATEBOARD

- TOO MUCH PDA (PUBLIC DISPLAY OF AFFECTION)

- SOMEONE WEARING A BANDANA

- SOMEONE RUNNING FOR A BUS

- A TREE TALLER THAN YOUR HOUSE

TURN THIS PAGE WITH YOUR NOSE



TURN TO PAGE 190

DOODLE

FILL THIS PAGE WITH DOODLES

HEAD TENNIS

LOOK RIGHT!





LOOK LEFT!

DRAW YOUR WEEK IN A STORYBOARD

WRITE HERE

DRAW HERE

DATE: / /

F-TEST!

COUNT EVERY "F" IN THE FOLLOWING TEXT

FUNNY FRIENDS ARE
THE RESULT OF YEARS
OF SCIENTIFIC STUDY
COMBINED WITH THE
EXPERIENCE OF YEARS...

WRITE WHAT YOU DID TODAY

...WITH YOUR OPPOSITE WRITING HAND

WHAT'S THE FIRST THING YOU DO IN THE MORNING AND WHY?

POINTLESS PAGE!

WHEN YOU SEE THIS PAGE FILL IT IN WITH WHATEVER YOU WANT!

The Pointless Book 139

RANDOM TWEET!

WHENEVER YOU OPEN
THE BOOK OR PASS
THIS PAGE YOU HAVE TO
TWEET SOMETHING WITH

#THEPOINTLESSBOOK

DRAW A 'SELFIE'





GLUE ALONG THIS EDGE

TIME CAPSULE

PUT SOMETHING BETWEEN THESE TWO PAGES
AND GLUE THEM TOGETHER. WRITE A DATE ON
THE NEXT PAGE AND DO NOT OPEN UNTIL THEN.



GLUE ALONG THIS EDGE





GLUE ALONG THIS EDGE



GLUE ALONG THIS EDGE

**DO NOT OPEN THIS
CAPSULE UNTIL**



DRAW YOUR PET

(IF YOU DON'T HAVE A PET DRAW A GOLDFISH!)

**WITH A FRIEND SEE HOW
LONG YOU CAN DIP A
COOKIE IN YOUR CUP
OF MILK BEFORE IT
BREAKS OFF**

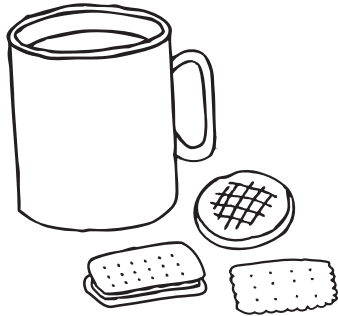

KEEP SCORE HERE:

YOU	FRIEND

**WRITE DOWN SOME FUNNY
OVERHEARD CONVERSATIONS...**

DRAW A LANDMARK...

...FROM A PLACE YOU WOULD LIKE TO VISIT

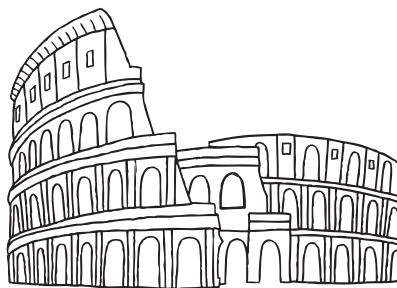

MAKE A FACE USING MAGAZINE CUT-OUTS...

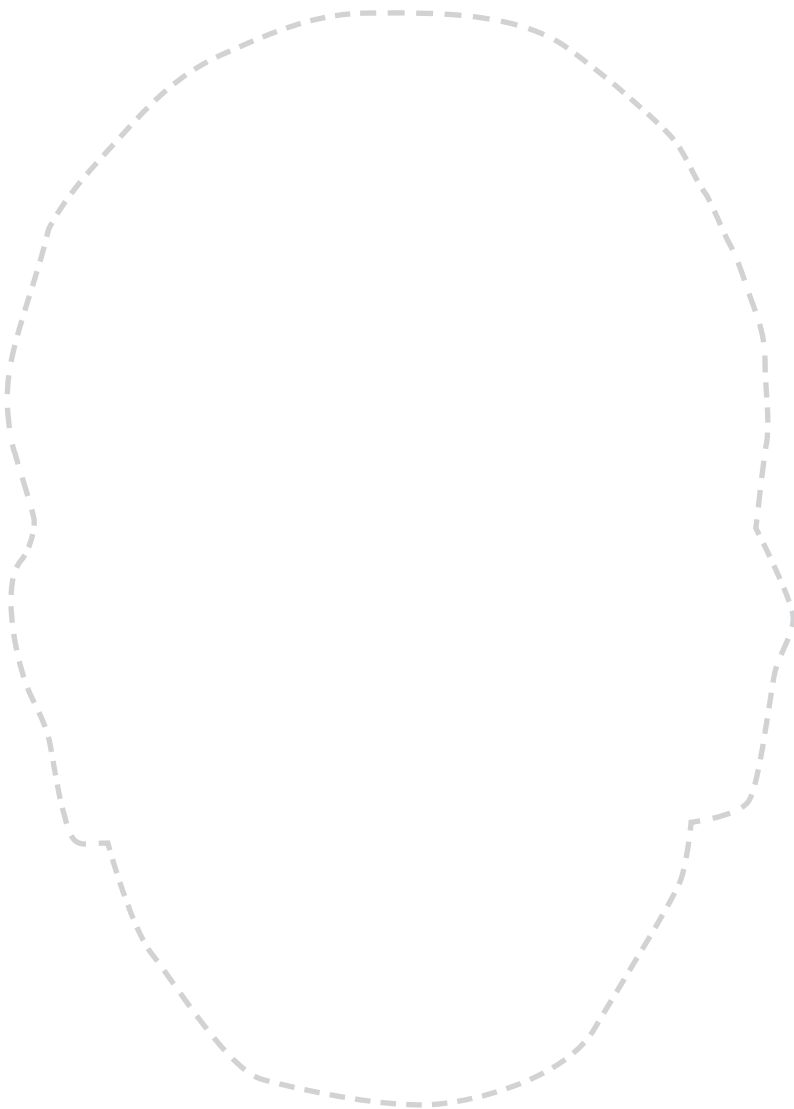

LIST YOUR TOP FIVE FILMS

1.

2.

3.

4.

5.

MY FIRST...

1. WORD

2. FRIEND

3. PET

4. KISS

5. FEAR

6. JOB

7. PHONE

STICK A PHOTO HERE OF WHEN
YOU WERE YOUNG



**DRAW WHAT YOU'D LIKE TO BE
WHEN YOU'RE OLDER**

ON THE BOARD BELOW WRITE DOWN THE NAME OF FOUR PEOPLE (TWO YOU LIKE, TWO YOU DISLIKE), FOUR COUNTRIES, AND FOUR RANDOM NUMBERS. GRAB A PEN AND TAP INSIDE THE BOX UNTIL A NOMINATED PLAYER SAYS 'STOP!' COUNT THE DOTS AND, BEGINNING WITH 'M', USE THIS NUMBER TO CROSS OFF THE ANSWERS SURROUNDING THE BOX, CROSSING OFF AN ANSWER EVERY TIME YOU GET TO YOUR NUMBER. THE GAME IS COMPLETE WHEN ONE ANSWER REMAINS IN EACH PANEL...

MASH

MANSION APARTMENT SHED HOUSE

NAMES

COUNTRIES

KIDS

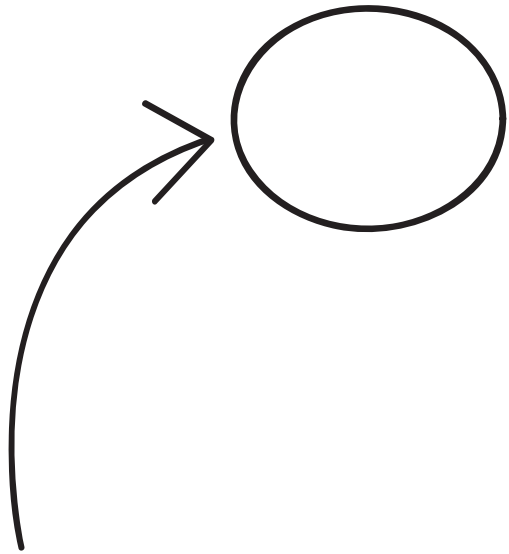

STICK CHEWING GUM
HERE AND FOLD THE CORNER

WHAT DID I DO ON THIS DAY...?

NEW YEAR'S DAY _____

EASTER MONDAY _____

ST PATRICK'S DAY _____

FOURTH OF JULY _____

HALLOWEEN _____

WHO WOULD YOU INVITE TO YOUR DREAM DINNER PARTY?

...CHOOSE ANYONE YOU LIKE, DEAD OR ALIVE.

WOULD YOU RATHER...

- 1) Be boiling hot or freezing cold?**

- 2) Have your computer memory wiped
or have your past and future web
browsing history available to everyone?**

- 3) Drink a cup of swimming pool water
or sea water?**

- 4) Hiccup for the rest of your life or feel
like you have to sneeze but can't for
the rest of your life?**

- 5) Listen to one song for the rest of your
life or never listen to the same song
twice?**

- 6) Not be able to use the internet or not
be able to listen to music?**

KISS, MARRY, AVOID...

KISS

MARRY

AVOID

KISS

MARRY

AVOID

KISS

MARRY

AVOID

**DESCRIBE YOURSELF IN
FIVE WORDS...**

USE THIS PAGE
WHEN YOU
DESPERATELY NEED
A PAPER TOWEL

...DON'T FORGET TO FLUSH...

TURN THIS PAGE WITH YOUR TOE



WHEN YOU SEE THIS PAGE FILL IT IN WITH WHATEVER YOU WANT!

POINTLESS PAGE!

TELL A
STRANGER
A JOKE



DID THEY:

1. LAUGH
2. CRY
3. THROW UP
4. RUN AWAY

ANAGRAM ANSWERS

GOBLIN TOPLESS

POINTLESS BLOG

EARN DUVET

ADVENTURE

MIMES MUTER

SUMMER TIME

HAT PAY SPY

STAY HAPPY

HAPPY HOG ROT

PHOTOGRAPHY

BRAIN-TEASER ANSWERS

WHAT
TRAVELS
AROUND THE WORLD
BUT STAYS IN THE
CORNER?

A POSTAGE STAMP

WHAT GETS
WETTER AND
WETTER THE MORE
IT DRIES?

A TOWEL

WHAT CAN
YOU CATCH
BUT CAN'T
THROW?

A COLD

WHICH WORD IN
THE DICTIONARY
IS SPELLED
INCORRECTLY?

INCORRECTLY

YOU CAN
HOLD IT WITHOUT
USING YOUR ARMS.
WHAT IS IT?

YOUR BREATH

WRITE FIVE THINGS YOU LIKE BEST ABOUT YOURSELF AND WHY...

1. _____

2. _____

3. _____

4. _____

5. _____

SCRAP PAPER...

...USE THIS PAGE WHEN
YOU NEED SOME PAPER

CREATE SOME ART HERE WITH THE

HOLES FROM THE HOLE-PUNCH PAGE!
(FROM PAGE 123)

BASKETBALL CHALLENGE

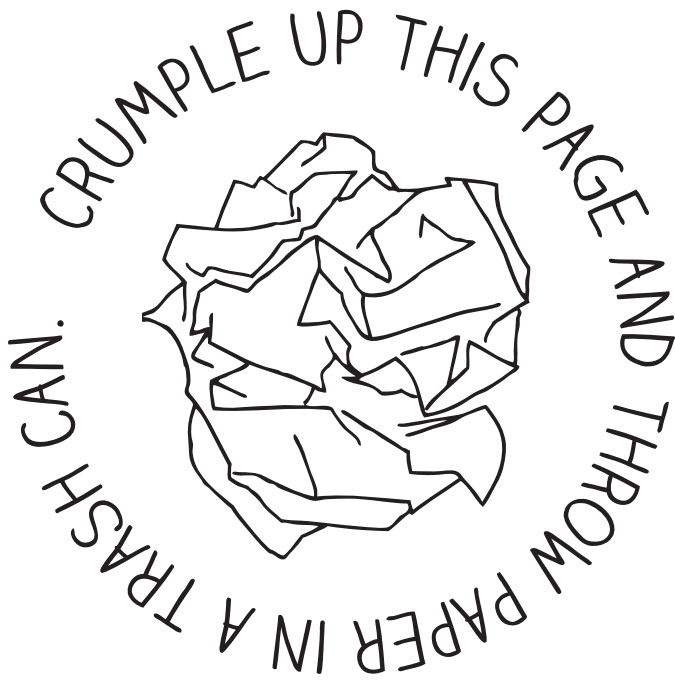



TOP FIVE THINGS...

...THAT MAKE YOU WANT TO THROW UP.

1.

2.

3.

4.

5.

CUT OUT NEWSPAPER HEADLINES...

...AND MAKE A STORY HERE!

WRITE A COMPLIMENT...

...RIP OUT THIS PAGE AND GIVE IT TO A STRANGER.

TEAR HERE

FILL THIS PAGE

WITH THINGS YOU LOVE...

SPOT THE DIFFERENCE
ANSWERS...



WORD SEARCH ANSWERS...

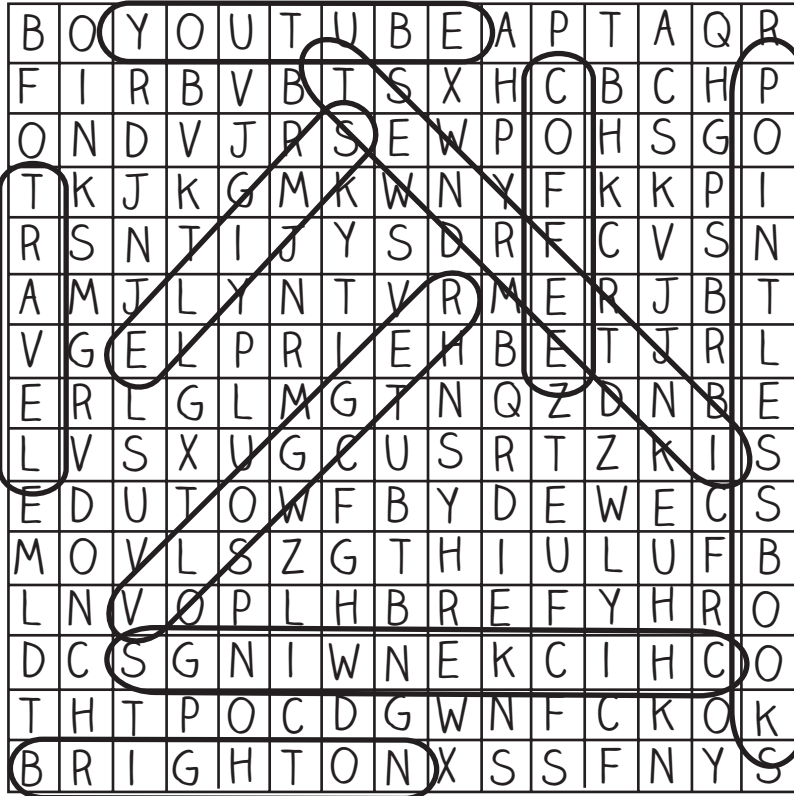

YOUTUBE
VLOGGER
POINTLESS BOOK

SMILE
BRIGHTON
TRAVEL

COFFEE
INTERNET
CHICKEN WINGS

BALANCE THE BOOK ON YOUR HEAD CHALLENGE!

INSTRUCTIONS:

1. CLOSE YOUR POINTLESS BOOK (NOT NOW—WAIT UNTIL YOU'VE READ ALL OF THE INSTRUCTIONS FIRST!).
2. STAND IN AN OPEN SPACE AND MAKE SURE THERE AREN'T ANY OBSTACLES IN YOUR WAY.
3. PLACE THE BOOK ON THE MIDDLE OF YOUR HEAD AND TAKE A STEP FORWARD.

HOW MANY STEPS CAN YOU TAKE?

TWEET YOUR BEST TIME TO **#THEPOINTLESSBOOK**

TURN TO PAGE 34



DRAW THE HYBRID ANIMALS

DRAW THESE HYBRID ANIMALS: A ZEDONKEY, A GORILLAROO,
A CABBIT AND A FROGODILE!

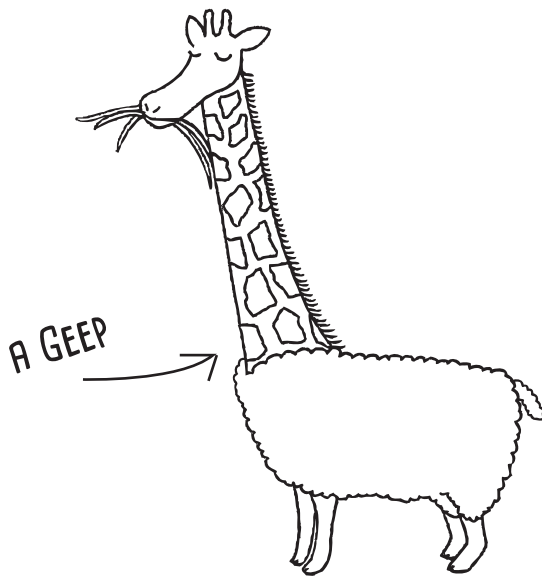

CELEBRITY FISH NAME GAME

FILL THESE PAGES WITH AS MANY CELEBRITY FISH NAMES YOU AND YOUR FRIENDS CAN THINK OF! HERE ARE A FEW TO START YOU OFF:

TUNA TURNER

MUSSEL CROWE

CALAMARI DIAZ

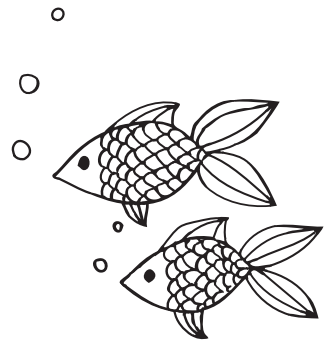

The Pointless Book 187

GIVE THIS BOOK TO A FRIEND...

...AND ASK THEM TO DESCRIBE YOU IN THREE WORDS:

1

2

3



DOODLE TIME

TURN TO PAGE 130



SUGGEST MORE WAYS THIS BOOK CAN BE POINTLESS.
FILL OUT THE BOXES BELOW AND SEND IT TO THE ADDRESS
OVERLEAF...

1.

2.

3.

4.

5.

6.

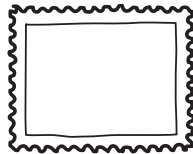

RUNNING PRESS

2300 CHESTNUT STREET,

SUITE 200

PHILADELPHIA, PA 19103

U.S.A.
